



National
Comprehensive
Cancer
Network®

NCCN Clinical Practice Guidelines in Oncology (NCCN Guidelines®)

Acute Lymphoblastic Leukemia

Version 1.2017 — June 1, 2017

NCCN.org

Continue



National
Comprehensive
Cancer
Network®

NCCN Guidelines Version 1.2017 Panel Members

Acute Lymphoblastic Leukemia

[NCCN Guidelines Index](#)
[Table of Contents](#)
[Discussion](#)

*** Patrick A. Brown, MD/Chair €**
The Sidney Kimmel Comprehensive
Cancer Center at Johns Hopkins

Anjali Advani, MD ‡ §
Case Comprehensive Cancer Center/
University Hospitals Seidman Cancer
Center and Cleveland Clinic Taussig
Cancer Institute

Patricia Aoun, MD, MPH ≠
City of Hope Comprehensive Cancer Center

Stefan K. Barta, MD, MS † ‡ P
Fox Chase Cancer Center

Michael W. Boyer, MD ‡ §
Huntsman Cancer Institute
at the University of Utah

Teresa Bryan, MD P
University of Alabama at Birmingham
Comprehensive Cancer Center

Patrick W. Burke, MD † ‡
University of Michigan
Comprehensive Cancer Center

Ryan Cassaday, MD † ‡ P
Fred Hutchinson Cancer Research Center/
Seattle Cancer Care Alliance

Peter F. Coccia, MD €
Fred & Pamela Buffett Cancer Center

Steven E. Coutre, MD ‡
Stanford Comprehensive Cancer Center

Lloyd E. Damon, MD ‡ §
UCSF Helen Diller Family
Comprehensive Cancer Center

Daniel J. DeAngelo, MD, PhD † ‡
Dana-Farber/Brigham and Women's
Cancer Center

Amir Fathi, MD † ‡ P
Massachusetts General Hospital
Cancer Center

Olga Frankfurt, MD ‡
Robert H. Lurie Comprehensive Cancer
Center of Northwestern University

John P. Greer, MD ‡ §
Vanderbilt-Ingram Cancer Center

Hagop M. Kantarjian, MD † ‡ P
The University of Texas
MD Anderson Cancer Center

Rebecca B. Klisovic, MD ‡ †
The Ohio State University Comprehensive
Cancer Center - James Cancer Hospital
and Solove Research Institute

Gary Kupfer, MD €
Yale Cancer Center/Smilow Cancer Hospital

Mark Litzow, MD ‡ §
Mayo Clinic Cancer Center

Arthur Liu, MD, PhD §
University of Colorado Cancer Center

Ryan Mattison, MD † ‡ P
University of Wisconsin
Carbone Cancer Center

Jae Park, MD †
Memorial Sloan Kettering Cancer Center

Jeffrey Rubnitz, MD €
St. Jude Children's Research Hospital/
The University of Tennessee Health
Science Center

Ayman Saad, MD † ‡ P §
University of Alabama at Birmingham
Comprehensive Cancer Center

Bijal Shah, MD †
Moffitt Cancer Center

Geoffrey L. Uy, MD ‡ † §
Siteman Cancer Center at Barnes-
Jewish Hospital and Washington
University School of Medicine

Eunice S. Wang, MD † ‡ P
Roswell Park Cancer Institute

Matthew Wieduwilt, MD, PhD ‡ §
UC San Diego Moores Cancer Center

NCCN

Kristina Gregory, RN, MSN, OCN
Ndiya Ogba, PhD

‡ Hematology/Hematology oncology
€ Pediatric oncology
≠ Pathology
† Medical oncology
P Internal medicine
§ Bone marrow transplantation
§ Radiotherapy/Radiation oncology
* Discussion Section Writing Committee

Continue

[NCCN Guidelines Panel Disclosures](#)



NCCN Guidelines Version 1.2017 Table of Contents

Acute Lymphoblastic Leukemia

[NCCN Acute Lymphoblastic Leukemia Panel Members](#)

[Summary of the Guidelines Updates](#)

[Diagnosis \(ALL-1\)](#)

[Workup and Risk Stratification \(ALL-2\)](#)

[Ph+ ALL \(AYA\) Treatment Induction and Consolidation Therapy \(ALL-3\)](#)

[Ph+ ALL \(Adult\) Treatment Induction and Consolidation Therapy \(ALL-4\)](#)

[Ph- ALL \(AYA\) Treatment Induction and Consolidation Therapy \(ALL-5\)](#)

[Ph- ALL \(Adult\) Treatment Induction and Consolidation Therapy \(ALL-6\)](#)

[Surveillance \(ALL-8\)](#)

[Relapsed/Refractory Disease, Treatment \(ALL-9\)](#)

[Cytogenetic Risk Groups for B-ALL \(ALL-A\)](#)

[Evaluation and Treatment of Extramedullary Involvement \(ALL-B\)](#)

[Supportive Care \(ALL-C\)](#)

[Principles of Systemic Therapy \(ALL-D\)](#)

[Response Assessment \(ALL-E\)](#)

[Minimal Residual Disease Assessment \(ALL-F\)](#)

Clinical Trials: NCCN believes that the best management for any patient with cancer is in a clinical trial. Participation in clinical trials is especially encouraged.

To find clinical trials online at NCCN Member Institutions, [click here: nccn.org/clinical_trials/physician.html](#).

NCCN Categories of Evidence and Consensus: All recommendations are category 2A unless otherwise specified.

See [NCCN Categories of Evidence and Consensus](#).

The NCCN Guidelines® are a statement of evidence and consensus of the authors regarding their views of currently accepted approaches to treatment. Any clinician seeking to apply or consult the NCCN Guidelines is expected to use independent medical judgment in the context of individual clinical circumstances to determine any patient's care or treatment. The National Comprehensive Cancer Network® (NCCN®) makes no representations or warranties of any kind regarding their content, use or application and disclaims any responsibility for their application or use in any way. The NCCN Guidelines are copyrighted by National Comprehensive Cancer Network®. All rights reserved. The NCCN Guidelines and the illustrations herein may not be reproduced in any form without the express written permission of NCCN. ©2017.



NCCN Guidelines Version 1.2017 Updates

Acute Lymphoblastic Leukemia

Updates in Version 1.2017 of the NCCN Guidelines for Acute Lymphoblastic Leukemia from Version 2.2016 include:

[ALL-1](#)

- **Diagnosis; bullet 3 added: Baseline characterization of leukemic clone to facilitate subsequent MRD analysis**
- **Genetic Characterization; bullet 3 modified: Reverse transcriptase-polymerase chain reaction (RT-PCR) testing for fusion genes (eg, *BCR-ABL1*) in B-ALL (quantitative or qualitative) including determination of transcript size (ie, p190 vs. p210)**
 - ▶ **Sub-bullet modified: If *BCR-ABL1* negative: testing for other fusions that are associated with describe-Ph-like ALL**
- **Additional optional tests include:**
 - ▶ **Bullet 1 modified: Consider additional assessment (array cGH) in case of aneuploidy or failed karyotype or hyperdiploidy and hypodiploidy**
- **Last statement modified: Strongly recommend that Patients should undergo evaluation and treatment at be treated in specialized centers.**
- **Footnote “a” modified: Subtypes: B-cell lymphoblastic leukemia/lymphoma with recurrent genetic abnormalities include hyperdiploidy, hypodiploidy, and commonly occurring translocations: t(9;22)(q34.1;q11.2)[*BCR-ABL1*]; t(v;11q23.3)[~~MLL~~-*KMT2A* rearranged]; t(12;21)(p13.2;q22.1)[*ETV6-RUNX1*]; t(1;19)(q23;p13.3)[*TCF3-PBX1*]; t(5;14)(q31;q32)[*IL3-IGH*;relatively rare]. B-cell lymphoblastic leukemia/lymphoma, not otherwise specified. T-cell lymphoblastic leukemia/lymphoma. Provisional entities: B-lymphoblastic leukemia/lymphoma, *BCR-ABL1*-like; B-lymphoblastic leukemia/lymphoma with *iAMP21*; Early T-cell precursor lymphoblastic leukemia.**
- **Footnote “e” modified: See Typical Immunophenotype by Major ALL Subtypes (ALL-A). The following immunophenotypic findings are particularly notable: CD10 negativity correlates with *KMT2A* rearrangement; ETP T-ALL; CD20 positivity: definition not clear, most studies have used >20% of blasts expressing CD20. See Discussion.**
- **Footnote “g” replaced with link to new page, Cytogenetic Risk Groups for B-ALL. Content from footnote “g” now contained on page ALL-B.**

[ALL-2](#)

- **Bullet 2 modified: Complete blood count (CBC), platelets, differential, chemistry profile, LFTs**
- **Bullet 5 added: Urinalysis**
- **Bullet 6 added: Hepatitis B/C, HIV, CMV Ab testing**
- **Bullet 7 added: Pregnancy testing, fertility counseling and preservation**
- **Bullet 9 modified: Lumbar puncture (LP) with IT chemotherapy**
- **Bullet 10 modified: CT of neck/chest/abdomen/pelvis with IV contrast and PET/CT if lymphomatous involvement is suspected (for patients with T-ALL). For patients with a mediastinal mass, baseline PET imaging is also recommended.**
- **Bullet 11 modified: Testicular exam, including scrotal ultrasound as indicated**
- **Bullet 12; sub-bullet 1 modified and combined with sub-bullet 2: Screen for active opportunistic infections if febrile or for symptomatic opportunistic infections. Initiate empirical treatment, as appropriate (See NCCN Guidelines for Prevention and Treatment of Cancer-Related Infections)**
- **Bullet 15 modified: Consider human leukocyte antigen (HLA) typing (except for patients with a major contraindication to hematopoietic cell transplant [HCT]) and Consider early evaluation and search for an family or an alternative donor**
- **Risk stratification modified with removal of age criteria for AYA and Adults.**
- **Footnote “k” added: The ALL panel considers AYA to be within the age range of 15–39 years. However, this age is not a firm reference point because some of the recommended regimens have not been comprehensively tested across all ages.**



NCCN Guidelines Version 1.2017 Updates

Acute Lymphoblastic Leukemia

Updates in Version 1.2017 of the NCCN Guidelines for Acute Lymphoblastic Leukemia from Version 2.2016 include:

[ALL-3](#)

- Treatment induction: TKIs + corticosteroids added as a treatment option.
- Footnote “s” added: Optimal timing of HCT is not clear. For fit patients, additional therapy may be considered to eliminate MRD prior to transplant. (also applies to ALL-4, ALL-5, ALL-7)
- Footnote “u” added: Duration of post-HCT or maintenance TKI should be a minimum of a year. The optimal duration is unknown. (also applies to ALL-4)
- Footnote “v” added: Consider periodic MRD monitoring (no more than every 3 months) for patients with complete molecular remission (undetectable levels). Increased frequency may be indicated for detectable levels. (also applies to ALL-4)

[ALL-4](#)

- Risk stratification modified: Patients <65 years of age ~~or patients with no~~ without substantial comorbidities

[ALL-5](#)

- Treatment induction:
 - ▶ "preferred" removed from pediatric-inspired regimens
 - ▶ "Other" removed before multiagent chemotherapy
- Consolidation therapy modified after CR with addition of MRD assessment categories:
 - ▶ *Persistent or late clearance MRD+*: *Blinatumomab (B-ALL)* or Consider allogeneic HCT
 - ▶ *MRD-*: Continue multiagent chemotherapy or Consider allogeneic HCT (especially if high WBC or B-ALL with poor-risk cytogenetics)
 - ▶ *MRD unknown*: Allogeneic HCT (especially if high WBC or B-ALL with poor-risk cytogenetics) or Consider continuing multiagent chemotherapy followed by maintenance therapy
- Footnote "aa" added: Although long-term remission after blinatumomab treatment is possible, allogeneic HCT should be considered as consolidative therapy.

[ALL-6](#)

- Risk stratification modified:
 - ▶ Patients <65 years of age ~~or patients with no~~ without substantial comorbidities
 - ▶ Patients ≥65 years of age or ~~patients with~~ substantial comorbidities
- Patients ≥65 years of age or ~~patients with~~ substantial comorbidities
 - ▶ Monitoring for MRD added after CR

[ALL-7](#)

- Previous page ALL-6 split, this page added to accommodate therapy options for Consolidation for patients <65 years of age without substantial comorbidities.
- Consolidation therapy modified after CR with addition of MRD assessment categories:
 - ▶ *Persistent or late clearance MRD+*: *Blinatumomab (B-ALL)* or Consider allogeneic HCT
 - ▶ *MRD-*: Continue multiagent chemotherapy or Consider allogeneic HCT (especially if high WBC or B-ALL with poor-risk cytogenetics)
 - ▶ *MRD unknown*: Allogeneic HCT (especially if high WBC or B-ALL with poor-risk cytogenetics) or Consider continuing multiagent chemotherapy followed by maintenance therapy



NCCN Guidelines Version 1.2017 Updates

Acute Lymphoblastic Leukemia

Updates in Version 1.2017 of the NCCN Guidelines for Acute Lymphoblastic Leukemia from Version 2.2016 include:

[ALL-8](#)

- Timing intervals removed from sub-bullets for CBC and LFTs
- Bullet 2: "every 3–6 months" added
- Bullet 3: "every 6–12 months or as indicated" added
- Bullet 5 added: Periodic *BCR-ABL1* transcript-specific quantification (Ph+ ALL)

[ALL-9](#)

- This page now addresses relapsed/refractory disease.
- Allogeneic HCT alone removed
- Ph+ ALL
 - ▶ "Consider ABL gene mutation testing" changed to "*ABL1* kinase domain mutation testing"
 - ▶ "Consider" removed before clinical trial
 - ▶ "HCT" added after treatment with TKI ± chemotherapy and TKI ± corticosteroids
 - ▶ Blinatumomab added as a treatment option after failure of 2 TKIs
- Ph- ALL
 - ▶ "Consider" removed before clinical trial
 - ▶ "HCT" added after treatment with chemotherapy
 - ▶ Blinatumomab added as a treatment option. This is a category 1 recommendation.
- Footnote "gg" modified with removal of last 2 sentences: Nelarabine is available for patients with relapsed T-ALL/lymphoblastic lymphoma. Clofarabine is available for patients age ≤21 y with relapsed or refractory ALL after at least 2 prior regimens. Vincristine sulfate liposome injection is available for adult patients with Ph- ALL in ≥ second relapse or disease progression after ≥2 therapies.

[ALL-A](#)

- Typical Immunophenotype by Major ALL Subtypes removed. Key information added to footnotes throughout algorithm.

[ALL-A](#)

- New page to address Cytogenetic Risk Groups for B-ALL (previous content from footnote g)
- The following added to poor-risk:
 - ▶ Ph-like ALL
 - ▶ Intrachromosomal amplification of chromosome 21 (iAMP21)

[ALL-B](#)

- First bullet removed: Given the risks of neurotoxicity associated with central nervous system (CNS)-directed therapy, baseline and post-treatment comprehensive neuropsychological testing may be useful.
- Bullet 6 and 9: cytarabine clarified as intermediate or high dose
- Bullet 7 modified: CNS leukemia (CNS-3 and/or cranial nerve involvement) at diagnosis typically warrants treatment with cranial irradiation of ≥18 Gy *in 1.8 to 2.0 Gy/fraction*. The recommended dose of radiation, where given, is highly dependent on the intensity of systemic chemotherapy; thus, it is critical to adhere to a given treatment protocol in its entirety. The entire brain and posterior half of the globe should be included. The inferior border should ~~be below~~ include C2.
- Last bullet; last sentence modified: Testicular total dose should be 24 Gy *in 2.0 Gy/fraction*.
- Reference removed: Gokbuget N, Hoelzer D. Treatment of adult acute lymphoblastic leukemia. Hematology Am Soc Hematol Educ Program 2006:133-141.



NCCN Guidelines Version 1.2017 Updates

Acute Lymphoblastic Leukemia

Updates in Version 1.2017 of the NCCN Guidelines for Acute Lymphoblastic Leukemia from Version 2.2016 include:

[ALL-C 1 of 4](#)

- Content for infection control removed as this information is included in the NCCN Guidelines for the Prevention and Treatment of Cancer-Related Infections.
- Methotrexate and Glucarpidase section modified:
 - ▶ Consider use of glucarpidase *in patients with* ~~if~~ significant renal dysfunction and *toxic plasma methotrexate concentrations with delayed methotrexate clearance levels are >10 microM beyond 42–48 h (plasma methotrexate concentrations >2 standard deviations of the mean methotrexate excretion curve specific for the dose of methotrexate administered)*. Leucovorin remains a component in the treatment of methotrexate toxicity and should be continued for at least 2 days following glucarpidase administration. However, be aware that leucovorin is a substrate for glucarpidase, and therefore should not be administered within two hours prior to or following glucarpidase.
- Steroid management; Acute side effects
 - ▶ Steroid-induced diabetes mellitus: "sliding scale" removed
 - ▶ Steroid-induced psychosis and mood alteration
 - ◇ "Consider dose reduction" changed to "Consider anti-psychotics. If no response, consider dose reduction"
 - ▶ Sub-bullet 3 modified: Use of a histamine-2 antagonist or proton pump inhibitor (PPI) ~~is recommended~~ *should be considered* during steroid therapy
 - ◇ Footnote moved to a bullet and modified: There may be important drug interactions *between PPIs and with* methotrexate that need to be considered prior to initiation of methotrexate-based therapy.
- Long-term side effects of corticosteroids
 - ▶ Bullet added: Consider withholding steroid in patients with severe necrosis.

[ALL-C 2 of 4](#)

- Gastroenterology
 - ▶ "if receiving vincristine" added after "Consider starting a bowel regimen to avoid constipation"

[ALL-C 3 of 4](#)

- First bullet added: Asparaginase should only be used in specialized centers.
- Hypersensitivity, Allergy, and Anaphylaxis
 - ▶ Bullet one modified: There is a significant incidence of hypersensitivity reactions with asparaginase products *in some regimens*.

[ALL-C 4 of 4](#)

- Non-CNS Thromboembolism
 - ▶ Bullet 2 added: Consider checking ATIII levels if administering heparin.
- Intracranial Hemorrhage
 - ▶ Bullet 2 added: MRA/MRV to rule out bleeding associated with sinus venous thrombosis.



NCCN Guidelines Version 1.2017 Updates

Acute Lymphoblastic Leukemia

Updates in Version 1.2017 of the NCCN Guidelines for Acute Lymphoblastic Leukemia from Version 2.2016 include:

[ALL-D 1 of 5](#)

- **Protocols for AYA patients**
 - ▶ **Bullet 3 modified with addition of ponatinib as a TKI option**
 - ▶ **Bullet 4 modified with addition of nilotinib as a TKI option**
 - ▶ **Bullet 5 added: TKIs (imatinib, dasatinib, nilotinib) + corticosteroids**
 - ▶ **Bullet 6 added: TKIs (imatinib, dasatinib, nilotinib) + vincristine + dexamethasone**
- **Adult patients**
 - ▶ **Bullet 1 modified with addition of ponatinib as a TKI option**
 - ▶ **Bullets 2 and 3 modified with addition of nilotinib as a TKI option**
 - ▶ **Bullet 4 modified with specification of TKIs imatinib, dasatinib, nilotinib**
- **Maintenance regimens**
 - ▶ **Bullet 1 modified with nilotinib and ponatinib added as TKI options**
- **Footnote "b" added: These regimens are used for induction therapy and additional therapy is needed.**

[ALL-D 2 of 5](#)

- **AYA patients**
 - ▶ **Categories of "pediatric-inspired protocols" and "other chemotherapy protocols" replaced with "Regimens based on data from multi-institutional or cooperative group studies" and "Regimens based on data from single institution studies"**
 - ◇ **Regimens based on data from multi-institutional or cooperative group studies**
 - **"with rituximab for CD20-positive disease" added to GRAALL regimen**
 - ◇ **Regimens based on data from single institution studies**
 - **Linker 4-drug regimen added as a treatment option**
- **Adult patients**
 - ▶ **GRAALL regimen with rituximab for CD20-positive disease added as a treatment option**
- **Maintenance regimen**
 - ▶ **Duration of "2–3 years" replaced with "duration based on regimen"**
- **Footnote "e" added: There are data to support the benefit of rituximab in addition to chemotherapy for CD20-positive patients (especially in patients <60 years).**
- **Footnote "f" added: Pediatric-inspired regimen.**



NCCN Guidelines Version 1.2017 Updates

Acute Lymphoblastic Leukemia

Updates in Version 1.2017 of the NCCN Guidelines for Acute Lymphoblastic Leukemia from Version 2.2016 include:

[ALL-D 3 of 5](#)

- A table added with Treatment Options Based on BCR-ABL1 Mutation Profile.
- Footnote "g" added: The safety of relapsed/refractory regimens in older adults (≥65) has not been established. Please see ALL-E 5 of 5 for additional information.
- Ph-positive ALL
 - ▶ "preferred" removed after the following TKI options: dasatinib, imatinib, ponatinib.
 - ▶ Bosutinib added as a treatment option.
 - ▶ Blinatumomab added as a treatment option after failure of 2 TKIs.
 - ▶ The following regimen added: MOpAD regimen: methotrexate, vincristine, pegaspargase, dexamethasone; with rituximab for CD20-positive disease. This is a category 2B recommendation.
- Ph-negative ALL
 - ▶ "preferred" removed after blinatumomab. Category designation changed from a category 2A to a category 1.
 - ▶ The following regimen added: MOpAD regimen: methotrexate, vincristine, pegaspargase, dexamethasone; with rituximab for CD20-positive disease

[ALL-D 4 of 5](#)

- The following references added: 7,10,32-35.

[ALL-D 5 of 5](#)

- New page added to address the Treatment of Older Adults with ALL

[ALL-E](#)

- Response Criteria for Mediastinal Disease changed to Response Criteria for *Lymphomatous Extramedullary Disease*
 - ▶ Bullet 1 modified: CT of *neck/chest/abdomen/pelvis* with IV contrast and PET/CT imaging should be performed to assess response for *extramedullary disease*.
 - ▶ Bullet 2 modified: CR: Complete resolution of ~~mediastinal-lymphomatous~~ enlargement by CT. For patients with a previous positive PET scan, a post-treatment residual mass of any size is considered a CR as long as it is PET negative.

[ALL-F](#)

- Bullet 1 added: The optimal sample for MRD assessment is the first pull or early pull of the bone marrow aspirate.
- Bullet 3 modified: MRD is an essential component of patient evaluation over the course of sequential therapy. If patient is not treated in an academic center, there are commercially available tests available for MRD assessment that should be used for MRD assessment.
- Bullet 5 modified: The most frequently employed methods for MRD assessment include multicolor flow cytometry assays specifically designed to detect abnormal MRD immunophenotypes, real-time quantitative polymerase chain reaction (RQ-PCR) assays, and next-generation sequencing-based assays to detect fusion genes (eg, BCR-ABL1), clonal rearrangements in immunoglobulin (Ig) heavy chain genes, and/or T-cell receptor (TCR) genes.
- Bullet 6 modified with removal of last sentence: The combined or tandem use of both methods allows for MRD monitoring in all patients, thereby avoiding potential false-negative results.
 - ▶ Timing of MRD assessment
 - ◇ Additional time points should be guided by ~~may be useful depending on~~ the regimen used.

**DIAGNOSIS**Acute
lymphoblastic
leukemia
(ALL)^{a,b,c}

The diagnosis of ALL generally requires demonstration of $\geq 20\%$ bone marrow lymphoblasts^d upon hematopathology review of bone marrow aspirate and biopsy materials, which includes:

- Morphologic assessment of Wright-Giemsa–stained bone marrow aspirate smears, and H&E–stained core biopsy and clot sections
- Comprehensive flow cytometric immunophenotyping^e
- Baseline characterization of leukemic clone to facilitate subsequent minimal residual disease (MRD) analysis

GENETIC CHARACTERIZATION

Optimal risk stratification and treatment planning requires testing marrow or peripheral blood lymphoblasts for specific recurrent genetic abnormalities using:

- Karyotyping of G-banded metaphase chromosomes
- Interphase fluorescence in situ hybridization (FISH) testing, including probes capable of detecting the major recurrent genetic abnormalities^a
- Reverse transcriptase-polymerase chain reaction (RT-PCR) testing *BCR-ABL1* in B-ALL (quantitative or qualitative) including determination of transcript size (ie, p190 vs. p210)
 - ▶ If *BCR-ABL1* negative: consider testing for other fusions that are associated with Ph-like ALL^f

Additional optional tests include:

- Consider additional assessment (array cGH) in cases of aneuploidy or failed karyotype

CLASSIFICATION

Together, these studies allow determination of the World Health Organization (WHO) ALL subtype^a and cytogenetic risk group^g

Patients should undergo evaluation and treatment at specialized centers

[See Workup
and Risk
Stratification
\(ALL-2\)](#)

^aSubtypes: B-cell lymphoblastic leukemia/lymphoma with recurrent genetic abnormalities include hyperdiploidy, hypodiploidy, and commonly occurring translocations: t(9;22)(q34.1;q11.2)[*BCR-ABL1*]; t(v;11q23.3)[*KMT2A* rearranged]; t(12;21)(p13.2;q22.1)[*ETV6-RUNX1*]; t(1;19)(q23;p13.3)[*TCF3-PBX1*]; t(5;14)(q31.1;q32.3)[*IL3-IGH*]. B-cell lymphoblastic leukemia/lymphoma, not otherwise specified. Provisional entities: B-lymphoblastic leukemia/lymphoma, *BCR-ABL1*–like; B-lymphoblastic leukemia/lymphoma with iAMP21; Early T-cell precursor lymphoblastic leukemia.

^bCriteria for classification of mixed phenotype acute leukemia (MPAL) should be based on the WHO 2016 criteria. Note that in ALL, myeloid-associated antigens such as CD13 and CD33 may be expressed, and the presence of these myeloid markers does not exclude the diagnosis of ALL, nor is it associated with adverse prognosis.

^cBurkitt leukemia/lymphoma, see the [NCCN Guidelines for B-Cell Lymphomas](#).

^dWhile these guidelines pertain primarily to patients with leukemia, patients with lymphoblastic lymphoma (LL) (B- or T-cell) would likely also benefit from ALL-like regimens. Such patients should be treated in a center that has experience with LL. See [Discussion](#).

^eThe following immunophenotypic findings are particularly notable: CD10 negativity correlates with *KMT2A* rearrangement; ETP T-ALL; CD20 positivity: definition not clear, most studies have used $>20\%$ of blasts expressing CD20. See [Discussion](#).

^fFor more information regarding Ph-like ALL, please see the [Discussion](#).

^gSee Cytogenetic Risk Groups for B-ALL ([ALL-A](#)).

Note: All recommendations are category 2A unless otherwise indicated.

Clinical Trials: NCCN believes that the best management of any patient with cancer is in a clinical trial. Participation in clinical trials is especially encouraged.



NCCN Guidelines Version 1.2017

Acute Lymphoblastic Leukemia

WORKUP^h

- History and physical (H&P)
- Complete blood count (CBC), platelets, differential, chemistry profile, LFTs
- Disseminated intravascular coagulation (DIC) panel: d-dimer, fibrinogen, prothrombin time (PT), partial thromboplastin time (PTT)
- Tumor lysis syndrome (TLS) panel: (LDH), uric acid, K, Ca, Phos (See Tumor Lysis Syndrome in the [NCCN Guidelines for B-Cell Lymphomas.](#))
- Urinalysis
- Hepatitis B/C, HIV, CMV Ab testing
- Pregnancy testing, fertility counseling and preservation
- CT/MRI of head with contrast, if neurologic symptomsⁱ
- Lumbar puncture (LP)^{i,j} with IT chemotherapy
 - ▶ [See Evaluation and Treatment of Extramedullary Involvement \(ALL-B\)](#)
- CT of neck/chest/abdomen/pelvis with IV contrast and PET/CT if lymphomatous involvement is suspected
- Testicular exam, including scrotal ultrasound as indicated
- Infection evaluation:
 - ▶ Screen for opportunistic infections, as appropriate ([See NCCN Guidelines for Prevention and Treatment of Cancer-Related Infections](#))
- Echocardiogram or cardiac nuclear medicine scan should be considered in all patients, since anthracyclines are important components of ALL therapy, but especially in patients with prior cardiac history and prior anthracycline exposure or clinical symptoms suggestive of cardiac dysfunction.
- Central venous access device of choice
- Consider human leukocyte antigen (HLA) typing and early evaluation and search for family or an alternative donor

RISK STRATIFICATION

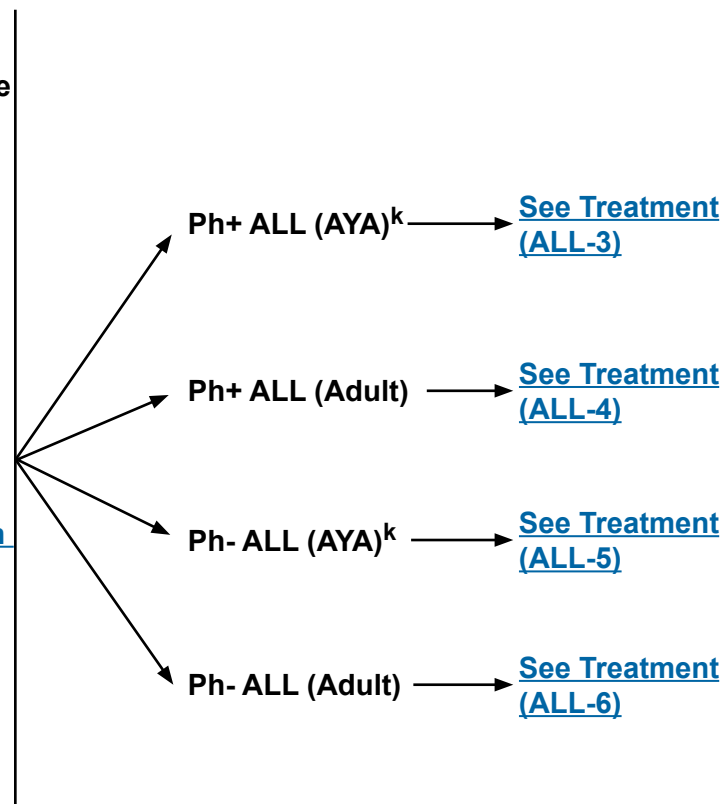

^hThe following list represents minimal recommendations; other testing may be warranted according to clinical symptoms and discretion of the clinician.

ⁱFor patients with major neurologic signs or symptoms at diagnosis, appropriate imaging studies should be performed to detect meningeal disease, choroidomas, or central nervous system (CNS) bleeding. [See Evaluation and Treatment of Extramedullary Involvement \(ALL-B\)](#).

^jTiming of LP should be consistent with the chosen treatment regimen. Pediatric-inspired regimens typically include LP and prophylactic IT chemotherapy at the time of diagnostic workup. The panel recommends that LP be done concurrently with initial IT therapy.

^kThe ALL panel considers AYA to be within the age range of 15–39 years. However, this age is not a firm reference point because some of the recommended regimens have not been comprehensively tested across all ages.

Note: All recommendations are category 2A unless otherwise indicated.

Clinical Trials: NCCN believes that the best management of any patient with cancer is in a clinical trial. Participation in clinical trials is especially encouraged.



NCCN Guidelines Version 1.2017

Acute Lymphoblastic Leukemia

RISK STRATIFICATION

TREATMENT INDUCTION^{n,o}

CONSOLIDATION THERAPY

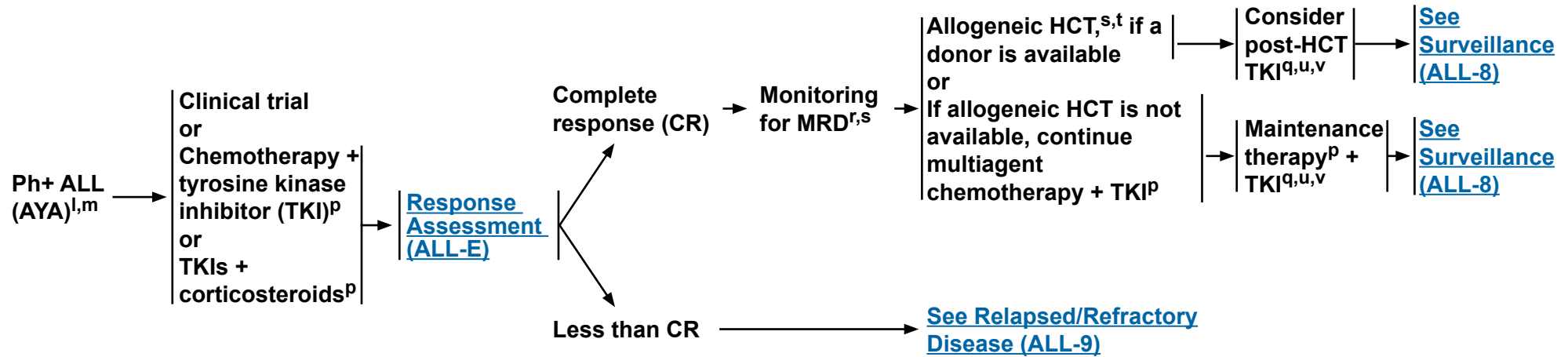

^lChronological age is a poor surrogate for fitness for therapy. Patients should be evaluated on an individual basis, including for the following factors: end-organ reserve, end-organ dysfunction, and performance status.

^mFor additional considerations in the management of AYA patients with ALL, see the [NCCN Guidelines for Adolescent and Young Adult Oncology](#).

ⁿAll ALL treatment regimens include CNS prophylaxis.

^oSee [Principles of Supportive Care \(ALL-C\)](#).

^pSee [Principles of Systemic Therapy \(ALL-D\)](#).

^qSee [Discussion section](#) for use of different TKIs in this setting.

^rSee [Minimal Residual Disease Assessment \(ALL-F\)](#).

^sOptimal timing of HCT is not clear. For fit patients, additional therapy may be considered to eliminate MRD prior to transplant.

^tEmerging data suggest that for younger patients (aged ≤21 y), allogeneic HCT may not offer an advantage over chemotherapy + TKIs; Schultz KR, Bowman WP, Aledo A, et al. Improved early event-free survival with imatinib in Philadelphia chromosome-positive acute lymphoblastic leukemia: a children's oncology group study. *J Clin Oncol* 2009;27:5175-5181.

^uDuration of post-HCT or maintenance TKI should be a minimum of a year. The optimal duration is unknown.

^vConsider periodic MRD monitoring (no more than every 3 months) for patients with complete molecular remission (undetectable levels). Increased frequency may be indicated for detectable levels.

Note: All recommendations are category 2A unless otherwise indicated.

Clinical Trials: NCCN believes that the best management of any patient with cancer is in a clinical trial. Participation in clinical trials is especially encouraged.



NCCN Guidelines Version 1.2017

Acute Lymphoblastic Leukemia

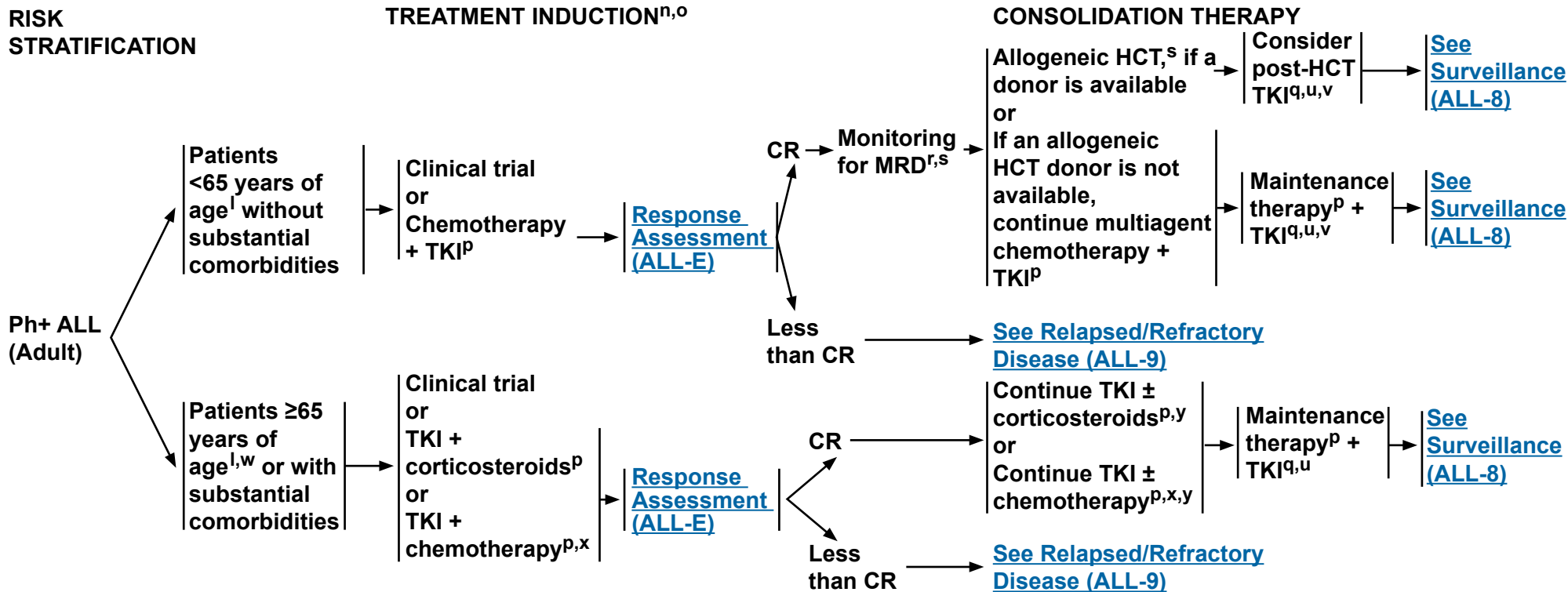

^lChronological age is a poor surrogate for fitness for therapy. Patients should be evaluated on an individual basis, including for the following factors: end-organ reserve, end-organ dysfunction, and performance status.

^mFor additional considerations in the management of AYA patients with ALL, see the [NCCN Guidelines for Adolescent and Young Adult Oncology](#).

ⁿAll ALL treatment regimens include CNS prophylaxis.

^oSee [Principles of Supportive Care \(ALL-C\)](#).

^pSee [Principles of Systemic Therapy \(ALL-D\)](#).

^qSee [Discussion section](#) for use of different TKIs in this setting.

^rSee [Minimal Residual Disease Assessment \(ALL-F\)](#).

^sOptimal timing of HCT is not clear. For fit patients, additional therapy may be considered to eliminate MRD prior to transplant.

^tEmerging data suggest that for younger patients (aged ≤21 y), allogeneic HCT may not offer an advantage over chemotherapy + TKIs; Schultz KR, Bowman

WP, Aledo A, et al. Improved early event-free survival with imatinib in Philadelphia chromosome-positive acute lymphoblastic leukemia: a children's oncology group study. *J Clin Oncol* 2009;27:5175-5181.

^uDuration of post-HCT or maintenance TKI should be a minimum of a year. The optimal duration is unknown.

^vConsider periodic MRD monitoring (no more than every 3 months) for patients with complete molecular remission (undetectable levels). Increased frequency may be indicated for detectable levels.

^wFor additional considerations in the management of older adult patients with ALL, see the [NCCN Guidelines for Older Adult Oncology](#).

^xConsider dose modifications appropriate for patient age and performance status.

^yAllogeneic HCT may be considered based on performance status, comorbidities, availability of appropriate transplant donor, and transplant center expertise in treating older patients with allogeneic HCT.

Note: All recommendations are category 2A unless otherwise indicated.

Clinical Trials: NCCN believes that the best management of any patient with cancer is in a clinical trial. Participation in clinical trials is especially encouraged.



NCCN Guidelines Version 1.2017 Acute Lymphoblastic Leukemia

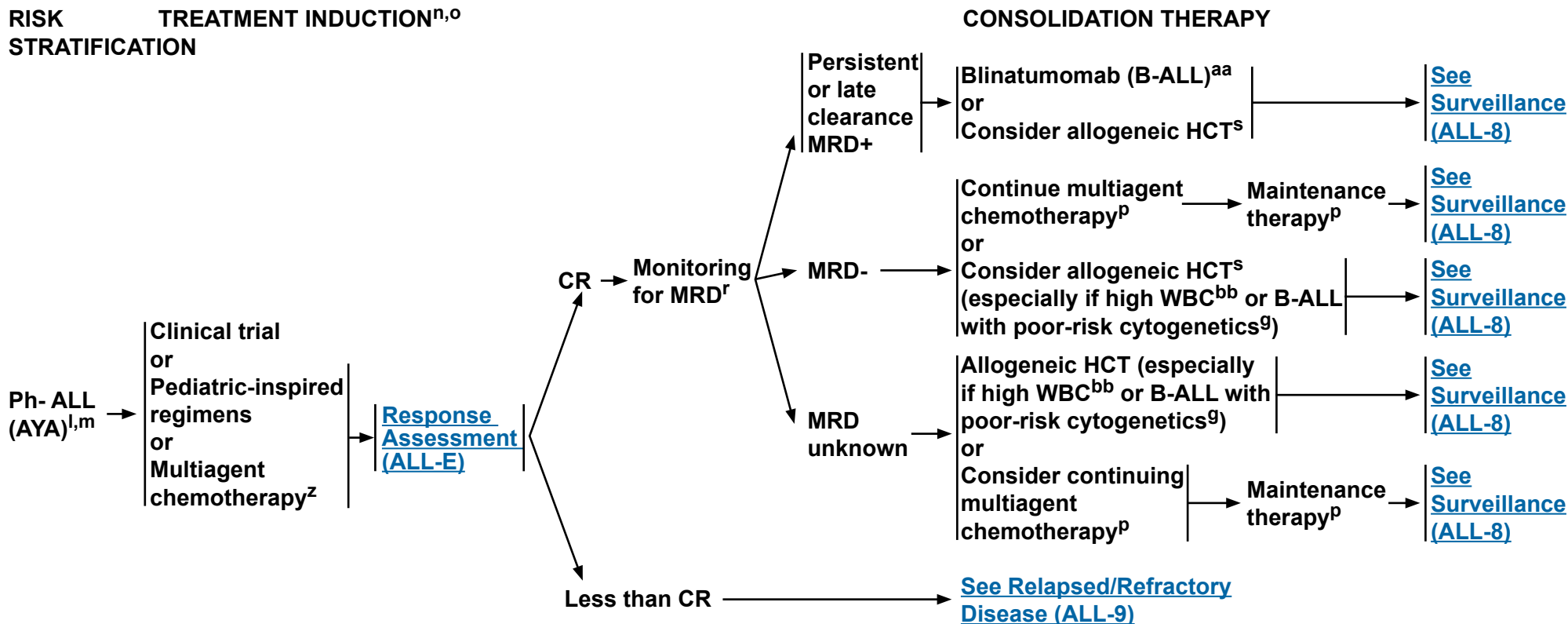

^gSee Cytogenetic Risk Groups for B-ALL ([ALL-A](#))

^lChronological age is a poor surrogate for fitness for therapy. Patients should be evaluated on an individual basis, including for the following factors: end-organ reserve, end-organ dysfunction, and performance status.

^mFor additional considerations in the management of AYA patients with ALL, see the [NCCN Guidelines for Adolescent and Young Adult Oncology](#).

ⁿAll ALL treatment regimens include CNS prophylaxis.

^o[See Principles of Supportive Care \(ALL-C\)](#).

^p[See Principles of Systemic Therapy \(ALL-D\)](#).

^r[See Minimal Residual Disease Assessment \(ALL-F\)](#).

^sOptimal timing of HCT is not clear. For fit patients, additional therapy may be considered to eliminate MRD prior to transplant.

^z[See Principles of Systemic Therapy \(ALL-D\)](#). All regimens include induction/delayed intensification (especially for pediatric-inspired regimens) and maintenance therapy.

^{aa}Although long-term remission after blinatumomab treatment is possible, allogeneic HCT should be considered as consolidative therapy.

^{bb}High WBC count ($\geq 30 \times 10^9/L$ for B lineage or $\geq 100 \times 10^9/L$ for T lineage) is considered a high-risk factor based on some studies in ALL. Data demonstrating the effect of WBC counts on prognosis are less firmly established for adults than for the pediatric population.

Note: All recommendations are category 2A unless otherwise indicated.

Clinical Trials: NCCN believes that the best management of any patient with cancer is in a clinical trial. Participation in clinical trials is especially encouraged.



NCCN Guidelines Version 1.2017

Acute Lymphoblastic Leukemia

RISK STRATIFICATION

TREATMENT INDUCTION^{n,o}

CONSOLIDATION THERAPY

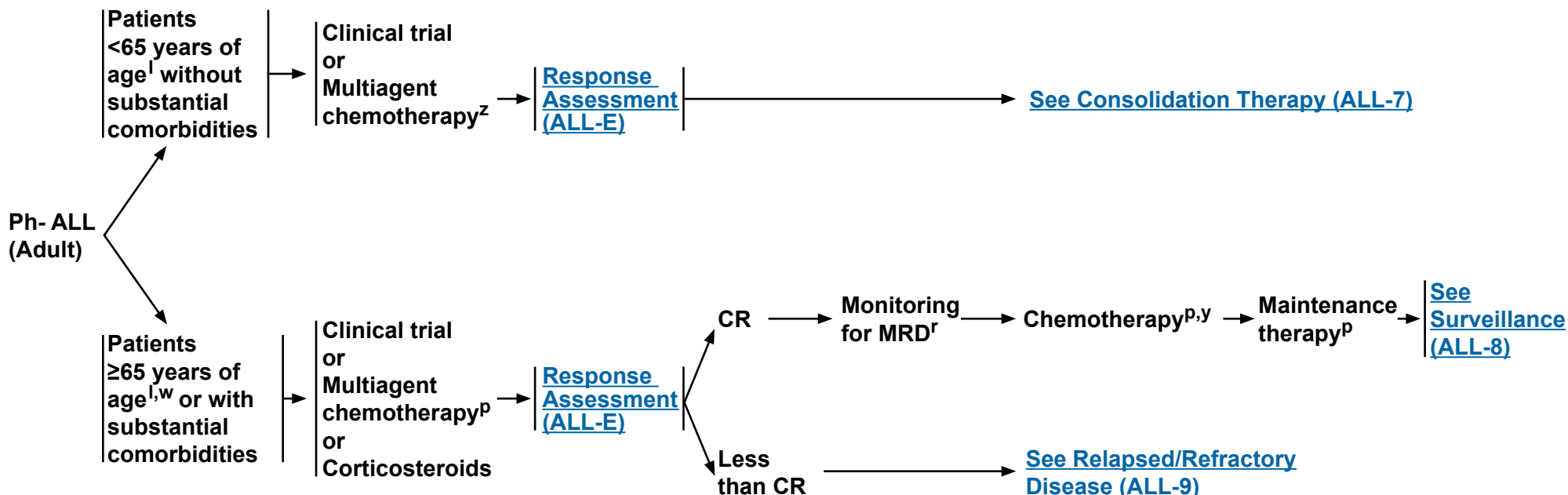

^lChronological age is a poor surrogate for fitness for therapy. Patients should be evaluated on an individual basis, including for the following factors: end-organ reserve, end-organ dysfunction, and performance status.

ⁿAll ALL treatment regimens include CNS prophylaxis.

^o[See Principles of Supportive Care \(ALL-C\).](#)

^p[See Principles of Systemic Therapy \(ALL-D\).](#)

^r[See Minimal Residual Disease Assessment \(ALL-F\).](#)

^wFor additional considerations in the management of older adult patients with ALL, see the [NCCN Guidelines for Older Adult Oncology](#).

^yAllogeneic HCT may be considered based on performance status, comorbidities, availability of appropriate transplant donor, and transplant center expertise in treating older patients with allogeneic HCT.

^z[See Principles of Systemic Therapy \(ALL-D\).](#) All regimens include induction/delayed intensification (especially for pediatric-inspired regimens) and maintenance therapy.

Note: All recommendations are category 2A unless otherwise indicated.

Clinical Trials: NCCN believes that the best management of any patient with cancer is in a clinical trial. Participation in clinical trials is especially encouraged.



NCCN Guidelines Version 1.2017

Acute Lymphoblastic Leukemia

Patients <65 years of age^l without substantial comorbidities

CONSOLIDATION THERAPY

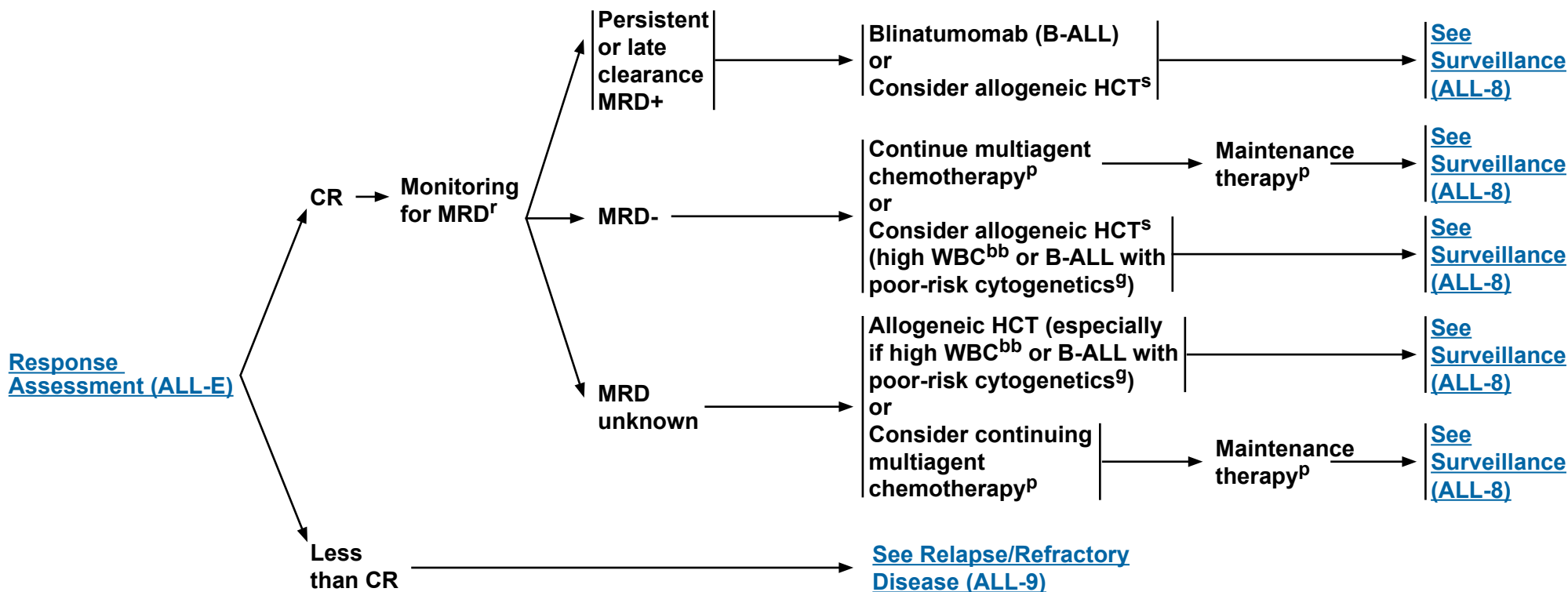

^gSee Cytogenetic Risk Groups for B-ALL ([ALL-A](#)).

^lChronological age is a poor surrogate for fitness for therapy. Patients should be evaluated on an individual basis, including for the following factors: end-organ reserve, end-organ dysfunction, and performance status.

^pSee [Principles of Systemic Therapy \(ALL-D\)](#).

^rSee [Minimal Residual Disease Assessment \(ALL-F\)](#).

^sOptimal timing of HCT is not clear. For fit patients, additional therapy may be considered to eliminate MRD prior to transplant.

^{bb}High WBC count ($\geq 30 \times 10^9/L$ for B lineage or $\geq 100 \times 10^9/L$ for T lineage) is considered a high-risk factor based on some studies in ALL. Data demonstrating the effect of WBC counts on prognosis is less firmly established for adults than for the pediatric population.

Note: All recommendations are category 2A unless otherwise indicated.

Clinical Trials: NCCN believes that the best management of any patient with cancer is in a clinical trial. Participation in clinical trials is especially encouraged.



NCCN Guidelines Version 1.2017

Acute Lymphoblastic Leukemia

SURVEILLANCE^{CC}

- Year 1 (every 1–2 months):
 - Physical exam, including testicular exam (where applicable),
 - CBC with differential
 - Liver function tests (LFTs) until normal
- Year 2 (every 3–6 months):
 - Physical exam including testicular exam (where applicable)
 - CBC with differential
- Year 3+ (every 6–12 months or as indicated):
 - Physical exam including testicular exam (where applicable)
 - CBC with differential
- Bone marrow aspirate, cerebrospinal fluid (CSF), and echocardiogram as indicated
 - If bone marrow aspirate is done: Flow cytometry with additional studies that may include comprehensive cytogenetics, FISH, and molecular testing.
- Periodic *BCR-ABL1* transcript-specific quantification (Ph+ ALL)
- Refer to Survivorship recommendations in the [NCCN Guidelines for Adolescent and Young Adult Oncology](#).
- Refer to the ALL Long-term Follow-up Guidelines from Children’s Oncology Group (COG): <http://www.survivorshipguidelines.org/>

→ [See Relapsed/
Refractory Disease
\(ALL-9\)](#)

^{CC}Surveillance recommendations apply after completion of chemotherapy, including maintenance.

Note: All recommendations are category 2A unless otherwise indicated.

Clinical Trials: NCCN believes that the best management of any patient with cancer is in a clinical trial. Participation in clinical trials is especially encouraged.



NCCN Guidelines Version 1.2017

Acute Lymphoblastic Leukemia

RELAPSED/REFRACTORY DISEASE

TREATMENT

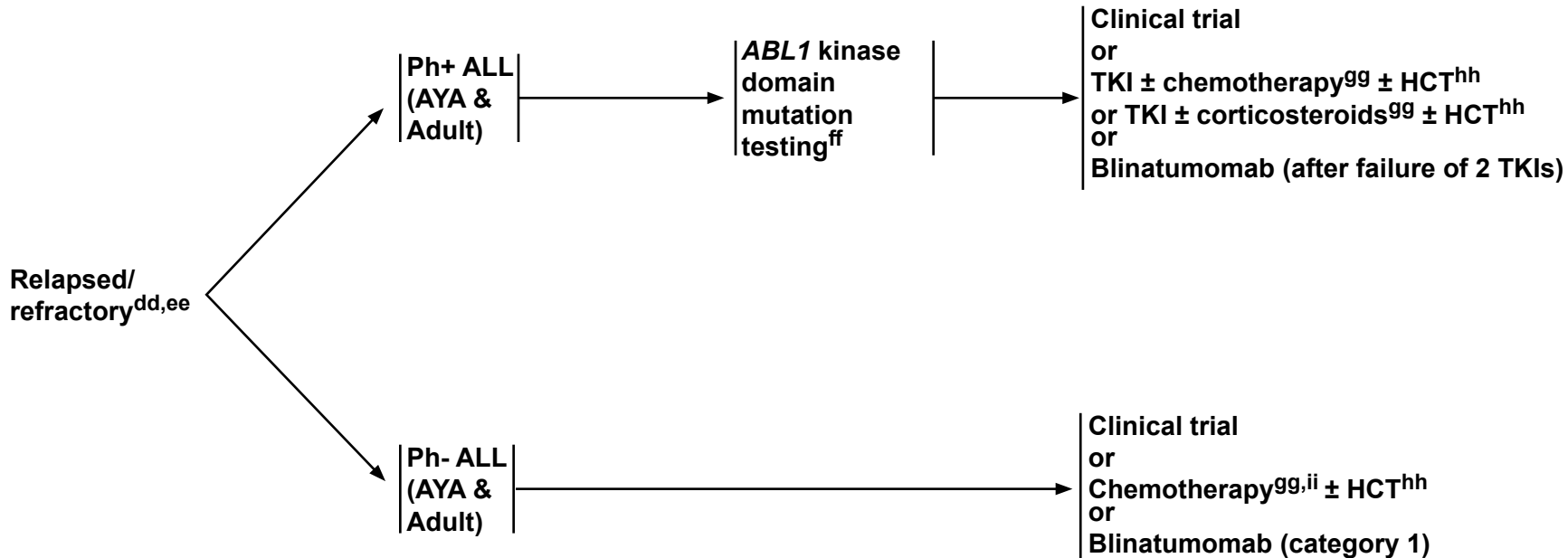

^{dd}Isolated extramedullary relapse (both CNS and testicular) requires systemic therapy to prevent relapse in marrow.

^{ee}See [NCCN Guidelines for Palliative Care](#).

^{ff}See [Treatment Options Based on BCR-ABL1 Mutation Profile \(ALL-D 3 of 5\)](#).

^{gg}See Principles of Systemic Therapy ([ALL-D 3 of 5](#)).

^{hh}For patients with relapsed disease after allogeneic HCT, a second allogeneic HCT and/or donor lymphocyte infusion (DLI) can be considered.

ⁱⁱFor patients in late relapse (>3 years from initial diagnosis), consider treatment with the same induction regimen (See [ALL-D 2 of 5](#)).

Note: All recommendations are category 2A unless otherwise indicated.
Clinical Trials: NCCN believes that the best management of any patient with cancer is in a clinical trial. Participation in clinical trials is especially encouraged.



NCCN Guidelines Version 1.2017

Acute Lymphoblastic Leukemia

CYTOGENETIC RISK GROUPS FOR B-ALL

RISK GROUPS	CYTOGENETICS
Good risk	Hyperdiploidy (51–65 chromosomes; cases with trisomy of chromosomes 4, 10, and 17 appear to have the most favorable outcome); t(12;21)(p13;q22): ETV6-RUNX1
Poor risk	Hypodiploidy (<44 chromosomes); t(v;11q23):t(4;11) and other KMT2A rearranged t(--;11q23); t(9;22)(q34;q11.2): BCR-ABL1 (defined as high risk in the pre-TKI era); complex karyotype (5 or more chromosomal abnormalities); Ph-like ALL; intrachromosomal amplification of chromosome 21 (iAMP21)

Note: All recommendations are category 2A unless otherwise indicated.
Clinical Trials: NCCN believes that the best management of any patient with cancer is in a clinical trial. Participation in clinical trials is especially encouraged.



NCCN Guidelines Version 1.2017

Acute Lymphoblastic Leukemia

EVALUATION AND TREATMENT OF EXTRAMEDULLARY INVOLVEMENT

- The aim of CNS prophylaxis and/or treatment is to clear leukemic cells within sites that cannot be readily accessed by systemic chemotherapy due to the blood-brain barrier, with the overall goal of preventing CNS disease or relapse.
- Factors associated with increased risks for CNS leukemia in adults include mature B-cell immunophenotype, T-cell immunophenotype, high presenting WBC counts, and elevated serum LDH levels.¹
- CNS involvement should be evaluated (by LP) at the appropriate timing:
 - ▶ Timing of LP should be consistent with the chosen treatment regimen.
 - ▶ Pediatric-inspired regimens typically include LP at the time of diagnostic workup.
 - ▶ The panel recommends that LP be done concurrently with initial IT therapy.
- Classification of CNS status:
 - ▶ CNS-1: No lymphoblasts in CSF regardless of WBC count.
 - ▶ CNS-2: WBC <5/mcL in CSF with presence of lymphoblasts.
 - ▶ CNS-3: WBC ≥5/mcL in CSF with presence of lymphoblasts.
 - ▶ If the patient has leukemic cells in the peripheral blood and the LP is traumatic and WBC ≥5/mcL in CSF with blasts, then compare the CSF WBC/RBC ratio to the blood WBC/RBC ratio. If the CSF ratio is at least two-fold greater than the blood ratio, then the classification is CNS-3; if not, then it is CNS-2.
- All patients with ALL should receive CNS prophylaxis. Although the presence of CNS involvement at the time of diagnosis is uncommon (about 3%–7%), a substantial proportion of patients (>50%) will eventually develop CNS leukemia in the absence of CNS-directed therapy.
- CNS-directed therapy may include cranial irradiation, IT chemotherapy (eg, methotrexate, cytarabine, corticosteroids), and/or systemic chemotherapy (eg, high-dose methotrexate, intermediate or high-dose cytarabine, mercaptopurine, pegaspargase).
- CNS leukemia (CNS-3 and/or cranial nerve involvement) at diagnosis typically warrants treatment with cranial irradiation of ≥18 Gy in 1.8 to 2.0 Gy/fraction. The recommended dose of radiation, where given, is highly dependent on the intensity of systemic chemotherapy; thus, it is critical to adhere to a given treatment protocol in its entirety. The entire brain and posterior half of the globe should be included. The inferior border should include C2.
- Note that areas of the brain targeted by the radiation field in the management of ALL are different from areas targeted for brain metastases of solid tumors.
- With the incorporation of adequate systemic chemotherapy (eg, high-dose methotrexate, intermediate or high-dose cytarabine) and IT chemotherapy regimens (eg, methotrexate alone or with cytarabine and a corticosteroid, which constitutes the triple IT regimen), it may be possible to avoid the use of upfront cranial irradiation except in cases of overt CNS leukemia at diagnosis, and to reserve the use of irradiation for relapsed/refractory therapy settings.
- Adequate systemic therapy should be given in the management of isolated CNS relapse.
- Patients with clinical evidence of testicular disease at diagnosis that is not fully resolved by the end of the induction therapy should be considered for radiation to the testes in the scrotal sac, which is typically done concurrently with the first cycle of maintenance chemotherapy. Testicular total dose should be 24 Gy in 2.0 Gy/fraction.

¹Lazarus HM, Richards SM, Chopra R, et al. Central nervous system involvement in adult acute lymphoblastic leukemia at diagnosis: results from the international ALL trial MRC UKALL XII/ECOG E2993. *Blood* 2006;108:465-472.

Note: All recommendations are category 2A unless otherwise indicated.

Clinical Trials: NCCN believes that the best management of any patient with cancer is in a clinical trial. Participation in clinical trials is especially encouraged.



SUPPORTIVE CARE (1 of 4)

Best supportive care

- Infection control ([See NCCN Guidelines for Prevention and Treatment of Cancer-Related Infections](#))
- Acute TLS (See Tumor Lysis Syndrome in the [NCCN Guidelines B-Cell Lymphomas](#))
- Pegaspargase Toxicity Management — see [ALL-C 3 of 4](#) and [ALL-C 4 of 4](#)
- Methotrexate and Glucarpidase
 - ▶ Consider use of glucarpidase in patients with significant renal dysfunction and toxic plasma methotrexate concentrations with delayed methotrexate clearance (plasma methotrexate concentrations >2 standard deviations of the mean methotrexate excretion curve specific for the dose of methotrexate administered). Leucovorin remains a component in the treatment of methotrexate toxicity and should be continued for at least 2 days following glucarpidase administration. However, be aware that leucovorin is a substrate for glucarpidase, and therefore should not be administered within two hours prior to or following glucarpidase.
- Steroid management
 - ▶ Acute side effects
 - ◇ Steroid-induced diabetes mellitus
 - Tight glucose control using insulin to decrease infection complications
 - ◇ Steroid-induced psychosis and mood alteration
 - Consider anti-psychotics. If no response, consider dose reduction
 - ◇ Use of a histamine-2 antagonist or proton pump inhibitor (PPI) should be considered during steroid therapy
 - There may be important drug interactions between PPIs and methotrexate that need to be considered prior to initiation of methotrexate-based therapy.
 - There are significant interactions between PPIs and TKIs regarding the bioavailability of certain BCR-ABL1 TKIs with gastric acid suppression that should be considered.
 - ▶ Long-term side effects of corticosteroids
 - ◇ Osteonecrosis/avascular necrosis (also [see Discussion](#))
 - Obtain vitamin D and calcium status and replete as needed
 - Consider radiographic evaluation with plain films or MRI or bone density study
 - Consider withholding steroid in patients with severe necrosis

[Continued on ALL-C 2 of 4](#)

Note: All recommendations are category 2A unless otherwise indicated.

Clinical Trials: NCCN believes that the best management of any patient with cancer is in a clinical trial. Participation in clinical trials is especially encouraged.



NCCN Guidelines Version 1.2017

Acute Lymphoblastic Leukemia

SUPPORTIVE CARE (2 of 4)

- **Transfusions**
 - ▶ **Products should be irradiated**
- **Use of granulocyte colony-stimulating factor (G-CSF)**
 - ▶ **Recommended for myelosuppressive blocks of therapy or as directed by treatment protocol**
- **Hyperleukocytosis**
 - ▶ **Although uncommon in patients with ALL, symptomatic hyperleukocytosis may require emergent treatment (See Symptomatic Leukocytosis in the [NCCN Guidelines for Acute Myeloid Leukemia](#))**
- **Antiemetics ([See NCCN Guidelines for Antiemesis](#))**
 - ▶ **Given as needed prior to chemotherapy and post chemotherapy**
 - ▶ **Routine use of corticosteroids as antiemetics are avoided**
- **Gastroenterology**
 - ▶ **Consider starting a bowel regimen to avoid constipation if receiving vincristine**
- **Nutritional support**
 - ▶ **Consider enteral or parenteral support for >10% weight loss**
- **Palliative treatment for pain ([See NCCN Guidelines for Cancer Pain](#))**

[Continued on ALL-C 3 of 4](#)

Note: All recommendations are category 2A unless otherwise indicated.

Clinical Trials: NCCN believes that the best management of any patient with cancer is in a clinical trial. Participation in clinical trials is especially encouraged.



SUPPORTIVE CARE (3 of 4) ASPARAGINASE TOXICITY MANAGEMENT

- Asparaginase should only be used in specialized centers
- There are two formulations of asparaginase in clinical use: 1) Pegaspargase (PEG); and 2) asparaginase Erwinia chrysanthemi (Erwinia). PEG is a common component of therapy for children, adolescents, and young adults with ALL. Both agents can be given intramuscularly (IM) or intravenously (IV); the IV route is increasingly being used. The toxicity profile of both asparaginase products presents significant challenges in clinical management. The following guidelines are intended to help providers address these challenges.
- For more detailed information, refer to Stock W, Douer D, DeAngelo DJ, et al. Prevention and management of asparaginase/pegasparaginase-associated toxicities in adults and older adolescents: recommendations of an expert panel. *Leuk Lymphoma* 2011;52:2237-2253. All toxicity grades refer to CTCAE v4.03. National Cancer Institute; National Institutes of Health. Common Terminology Criteria for Adverse Events (CTCAE) version 4.03 2010. Available at: http://evs.nci.nih.gov/ftp1/CTCAE/CTCAE_4.03_2010-06-14_QuickReference_8.5x11.pdf.

Hypersensitivity, Allergy, and Anaphylaxis

- There is a significant incidence of hypersensitivity reactions with asparaginase products in some regimens. Of particular concern are Grade 2 or higher systemic allergic reactions, urticaria, or anaphylaxis, because these episodes can be (but are not necessarily) associated with neutralizing antibodies and lack of efficacy.
- Erwinia is commonly used as a second-line agent in patients who have developed a systemic allergic reaction or anaphylaxis due to PEG hypersensitivity.
- Anaphylaxis or other allergic reactions of Grade 3-4 severity (CTCAE 4.0) merit permanent discontinuation of the type of asparaginase that caused the reaction.
- For Grade 1 reactions and Grade 2 reactions (rash, flushing, urticaria, and drug fever $\geq 38^{\circ}\text{C}$) without bronchospasm, hypotension, edema, or need for parenteral intervention, the asparaginase that caused the reaction may be continued, with consideration for anti-allergy premedication (such as hydrocortisone, diphenhydramine, and acetaminophen).
- If anti-allergy premedication is used prior to PEG or Erwinia administration, consideration should be given to therapeutic drug monitoring (TDM) using commercially available asparaginase activity assays, since premedication may “mask” the systemic allergic reactions that can indicate the development of neutralizing antibodies.¹

Pancreatitis

- Permanently discontinue asparaginase in the presence of Grade 3 or 4 pancreatitis. In the case of Grade 2 pancreatitis (enzyme elevation or radiologic findings only), asparaginase should be held until these findings normalize and then resume.

[Continued on ALL-C 4 of 4](#)

¹Bleyer A, Asselin BL, Koontz SE, Hunger S. Clinical application of asparaginase activity levels following treatment with pegaspargase. *Pediatr Blood Cancer* 2015;62:1102-1105.

Note: All recommendations are category 2A unless otherwise indicated.

Clinical Trials: NCCN believes that the best management of any patient with cancer is in a clinical trial. Participation in clinical trials is especially encouraged.



SUPPORTIVE CARE (4 of 4) ASPARAGINASE TOXICITY MANAGEMENT

Non-CNS Hemorrhage

- For Grade 2 or greater hemorrhage, hold asparaginase until Grade 1, then resume. Consider coagulation factor replacement. Do not hold for asymptomatic abnormal laboratory investigations.

Non-CNS Thromboembolism

- For Grade 2 or greater thromboembolic event, hold asparaginase until resolved and treat with appropriate antithrombotic therapy. Upon resolution of symptoms and antithrombotic therapy stable or completed, consider resuming asparaginase.
- Consider checking ATIII levels if administering heparin.

Intracranial Hemorrhage

- Discontinue asparaginase. Consider coagulation factor replacement. For Grade 3 or less, if symptoms/signs fully resolve, consider resuming asparaginase at lower doses and/or longer intervals between doses. For Grade 4, permanently discontinue asparaginase.
- MRA/MRV to rule out bleeding associated with sinus venous thrombosis.

Cerebral Thrombosis, Ischemia, or Stroke

- Discontinue asparaginase. Consider antithrombotic therapy. For Grade 3 or less, if symptoms/signs fully resolve, consider resuming asparaginase at lower doses and/or longer intervals between doses. For Grade 4, permanently discontinue asparaginase.

Hyperglycemia

- Treat hyperglycemia with insulin as indicated. For Grade 3 or higher, hold asparaginase and steroids until blood glucose has been regulated with insulin, then resume.

Hypertriglyceridemia

- Treat hypertriglyceridemia as indicated. For Grade 4, hold asparaginase until normalized, then resume.

Hepatotoxicity (elevation in bilirubin, AST, ALT)

- For direct bilirubin ≤ 3.0 mg/dL, continue asparaginase. For direct bilirubin 3.1–5.0 mg/dL, hold asparaginase until < 2.0 mg/dL, then resume. For direct bilirubin > 5.0 , either discontinue asparaginase or hold asparaginase until < 2.0 mg/dL, then resume with very close monitoring.
- For Grade 3 AST or ALT elevation, hold until Grade 1, then resume. For Grade 4 AST or ALT elevation, hold until Grade 1. If resolution to Grade 1 takes 1 week or less, then resume. Otherwise, either discontinue or resume with very close monitoring.

Note: All recommendations are category 2A unless otherwise indicated.

Clinical Trials: NCCN believes that the best management of any patient with cancer is in a clinical trial. Participation in clinical trials is especially encouraged.

**PRINCIPLES OF SYSTEMIC THERAPY (1 of 5)****INDUCTION REGIMENS FOR Ph-POSITIVE ALL^a****Protocols for AYA patients:**

- COG AALL-0031 regimen: vincristine, prednisone (or dexamethasone), and pegaspargase, with or without daunorubicin; or prednisone (or dexamethasone) and pegaspargase with or without daunorubicin; imatinib added during consolidation blocks¹
- EsPhALL regimen: imatinib; and a backbone of the Berlin-Frankfurt-Münster regimen²
- TKIs (ponatinib, imatinib, dasatinib) + hyper-CVAD (hyper-fractionated cyclophosphamide, vincristine, doxorubicin, and dexamethasone), alternating with high-dose methotrexate, and cytarabine³⁻⁷
- TKIs (imatinib, nilotinib) + multiagent chemotherapy (daunorubicin, vincristine, prednisone, and cyclophosphamide)⁸⁻¹⁰
- TKIs (imatinib, dasatinib, nilotinib)^{11,12} + corticosteroids^b
- TKIs (imatinib, dasatinib, nilotinib) + vincristine + dexamethasone^{13,14,b}

Adult patients: [Treatment of Older Patients \(≥65 y\) with ALL \(ALL-D 5 of 5\)](#)

- TKIs (ponatinib, imatinib, dasatinib) + hyper-CVAD (hyper-fractionated cyclophosphamide, vincristine, doxorubicin, and dexamethasone), alternating with high-dose methotrexate, and cytarabine³⁻⁷
- TKIs (imatinib, nilotinib) + multiagent chemotherapy: daunorubicin, vincristine, prednisone, and cyclophosphamide⁸⁻¹⁰
- TKIs (imatinib, dasatinib, nilotinib)^{11,12} + corticosteroids^b
- TKIs (imatinib, dasatinib, nilotinib) + vincristine + dexamethasone^{13,14,b}

Maintenance regimens:

- Add TKIs (imatinib, dasatinib, nilotinib, ponatinib) to maintenance regimen
- Monthly vincristine/prednisone pulses (for 2–3 years). May include weekly methotrexate + daily 6-mercaptopurine (6-MP) as tolerated^{c,d}

[Induction Regimens for Ph-Negative ALL \(ALL-D 2 of 5\)](#)[References \(ALL-D 4 of 5\)](#)

^aAll regimens include CNS prophylaxis with systemic therapy (eg, methotrexate, cytarabine, 6-mercaptopurine) and/or IT therapy (eg, IT methotrexate, IT cytarabine; triple IT therapy with methotrexate, cytarabine, corticosteroid).

^bThese regimens are used for induction therapy and additional therapy is needed.

^cFor patients receiving 6-MP, consider testing for TPMT gene polymorphisms, particularly in patients who develop severe neutropenia after starting 6-MP.

^dDose modifications for antimetabolites in maintenance should be consistent with the chosen treatment regimen. It may be necessary to reduce dose/eliminate antimetabolite in the setting of myelosuppression and/or hepatotoxicity.

Note: All recommendations are category 2A unless otherwise indicated.

Clinical Trials: NCCN believes that the best management of any patient with cancer is in a clinical trial. Participation in clinical trials is especially encouraged.



NCCN Guidelines Version 1.2017

Acute Lymphoblastic Leukemia

PRINCIPLES OF SYSTEMIC THERAPY (2 of 5)

INDUCTION REGIMENS FOR Ph-NEGATIVE ALL^{a,e}

AYA patients:

• Regimens based on data from multi-institutional or cooperative group studies:

- ▶ CALGB 10403 regimen: daunorubicin, vincristine, prednisone, and pegaspargase (ongoing study in patients aged <40 years)^{15,f}
- ▶ COG AALL0232 regimen: daunorubicin, vincristine, prednisone, and pegaspargase (patients aged ≤21 years)^{16,f}
- ▶ COG AALL0434 regimen with nelarabine (for T-ALL): daunorubicin, vincristine, prednisone, and pegaspargase; nelarabine added to consolidation regimen^{17,f}
- ▶ DFCI ALL regimen based on DFCI Protocol 00-01: doxorubicin, vincristine, prednisone, high-dose methotrexate, and pegaspargase (ongoing study in patients aged <50 years)^{18,f}
- ▶ GRAALL-2005 regimen: daunorubicin, vincristine, prednisone, pegaspargase, and cyclophosphamide (patients aged <60 years), with rituximab for CD20-positive disease^{19,f}
- ▶ PETHEMA ALL-96 regimen: daunorubicin, vincristine, prednisone, pegaspargase, and cyclophosphamide (patients aged <30 years)^{20,f}

• Regimens based on data from single institution studies:

- ▶ Hyper-CVAD ± rituximab: hyperfractionated cyclophosphamide, vincristine, doxorubicin, and dexamethasone, alternating with high-dose methotrexate and cytarabine; with or without rituximab for CD20-positive disease²¹
- ▶ USC ALL regimen based on CCG-1882 regimen: daunorubicin, vincristine, prednisone, and methotrexate with augmented pegaspargase (patients aged 18–57 years)^{22,f}
- ▶ Linker 4-drug regimen: daunorubicin, vincristine, prednisone, and pegaspargase²³

Adult patients: [Treatment of Older Patients \(≥65 y\) with ALL \(ALL-D 5 of 5\)](#)

- CALGB 8811 Larson regimen: daunorubicin, vincristine, prednisone, pegaspargase, and cyclophosphamide; for patients aged ≥60 years, reduced doses for cyclophosphamide, daunorubicin, and prednisone²⁴
- GRAALL-2005 regimen: daunorubicin, vincristine, prednisone, pegaspargase, and cyclophosphamide (patients aged <60 years) with rituximab for CD20-positive disease^{19,e}
- Hyper-CVAD ± rituximab: hyperfractionated cyclophosphamide, vincristine, doxorubicin, and dexamethasone, alternating with high-dose methotrexate and cytarabine; with or without rituximab for CD20-positive disease^{21,25}
- Linker 4-drug regimen: daunorubicin, vincristine, prednisone, and pegaspargase²³
- MRC UKALLXII/ECOG2993 regimen: daunorubicin, vincristine, prednisone, and pegaspargase (induction phase I); and cyclophosphamide, cytarabine, and 6-MP^c (induction phase II)²⁶

[Induction Regimens for Ph-Positive ALL \(ALL-D 1 of 5\)](#)

[References \(ALL-D 4 of 5\)](#)

Maintenance regimen:

- Weekly methotrexate + daily 6-MP^c + monthly vincristine/prednisone pulses (duration based on regimen)

^aAll regimens include CNS prophylaxis with systemic therapy (eg, methotrexate, cytarabine, 6-mercaptopurine) and/or IT therapy (eg, IT methotrexate, IT cytarabine; triple IT therapy with methotrexate, cytarabine, corticosteroid).

^cFor patients receiving 6-MP, consider testing for TPMT gene polymorphisms, particularly in patients who develop severe neutropenia after starting 6-MP.

^eThere are data to support the benefit of rituximab in addition to chemotherapy for CD20-positive patients (especially in patients <60 years).

^fPediatric-inspired regimen.

Note: All recommendations are category 2A unless otherwise indicated.

Clinical Trials: NCCN believes that the best management of any patient with cancer is in a clinical trial. Participation in clinical trials is especially encouraged.



NCCN Guidelines Version 1.2017

Acute Lymphoblastic Leukemia

PRINCIPLES OF SYSTEMIC THERAPY (3 of 5)

REGIMENS FOR RELAPSED OR REFRACTORY ALL^{a,9}

Ph-positive ALL:

- Dasatinib^{27,28}
- Imatinib²⁹
- Ponatinib^{30,h}
- Nilotinib³¹
- Bosutinib³²
- Blinatumomab (after failure of 2 TKIs)³³
- The TKIs noted above may also be used in combination with any of the induction regimens noted on [ALL-D 1 of 5](#) that were not previously given.
- MOpAD regimen (category 2B): methotrexate, vincristine, pegaspargase, dexamethasone; with rituximab for CD20-positive disease and TKI.³⁴
- The regimens listed below for Ph-negative ALL may be considered for Ph-positive ALL refractory to TKIs.

Ph-negative ALL:

- Blinatumomab (for B-ALL) (category 1)^{35,i}
- Cytarabine-containing regimens³⁶
- Alkylator combination regimens³⁷
- Nelarabine (for T-ALL)³⁸
- Augmented hyper-CVAD: hyper-fractionated cyclophosphamide, intensified vincristine, doxorubicin, intensified dexamethasone, and pegaspargase; alternating with high-dose methotrexate and cytarabine³⁹
- Vincristine sulfate liposome injection (VSLI)^{40,41}
- Clofarabine-containing regimens (for B-ALL)^{42,43}
- MOpAD regimen: methotrexate, vincristine, pegaspargase, dexamethasone; with rituximab for CD20-positive disease.³⁴

[References \(ALL-D 4 of 5\)](#)

^aAll regimens include CNS prophylaxis with systemic therapy (eg, methotrexate, cytarabine, 6-mercaptopurine) and/or IT therapy (eg, IT methotrexate, IT cytarabine; triple IT therapy with methotrexate, cytarabine, corticosteroid).

⁹The safety of relapsed/refractory regimens in older adults (≥65) has not been established. Please see [ALL-E 5 of 5](#) for additional information.

^hPonatinib has activity against T315I mutations and is effective in treating patients with resistant or progressive disease on multiple TKIs. However, it is associated with a high frequency of serious vascular events (eg, strokes, heart attacks, tissue ischemia). The FDA indications are for the treatment of adult patients with T315I-positive Philadelphia chromosome-positive acute lymphoblastic leukemia (Ph+ ALL) and for the treatment of adult patients with Ph+ ALL for whom no other TKI therapy is indicated. For details, see http://www.accessdata.fda.gov/drugsatfda_docs/label/2013/203469s007s008lbl.pdf.

ⁱBlinatumomab may cause severe, life-threatening, or fatal adverse events, including cytokine release syndrome and neurologic toxicities. Understanding of the risk evaluation and mitigation strategy (REMS) program and/or experience in the use of the drug as well as resources to monitor the patient closely are essential. It is important that the instruction for blinatumomab product preparation (including admixing) and administration are strictly followed to minimize medication errors, including underdose and overdose. For details, see <http://www.accessdata.fda.gov/scripts/cder/drugsatfda/index.cfm?fuseaction=Search.DrugDetails>.

Note: All recommendations are category 2A unless otherwise indicated.

Clinical Trials: NCCN believes that the best management of any patient with cancer is in a clinical trial. Participation in clinical trials is especially encouraged.

TREATMENT OPTIONS BASED ON BCR-ABL1 MUTATION PROFILE

Mutation	Treatment Recommendation
Y253H, E255K/V, or F359V/C/I	Dasatinib
F317L/V/I/C, T315A, or V299L	Nilotinib
E255K/V, F317L/V/I/C, F359V/C/I, T315A, or Y253H	Bosutinib
T315I	Ponatinib



NCCN Guidelines Version 1.2017

Acute Lymphoblastic Leukemia

PRINCIPLES OF SYSTEMIC THERAPY (4 of 5) — References

- ¹Schultz KR, Bowman WP, Aledo A, et al. Improved early event-free survival with imatinib in Philadelphia chromosome-positive acute lymphoblastic leukemia: a children's oncology group study. *J Clin Oncol* 2009;27:5175-5181.
- ²Biondi A, Schrappe M, De Lorenzo P, et al. Imatinib after induction for treatment of children and adolescents with Philadelphia-chromosome-positive acute lymphoblastic leukaemia (EsPhALL): a randomised, open-label, intergroup study. *Lancet Oncol* 2012;13:936-945.
- ³Ravandi F, O'Brien S, Thomas D, et al. First report of phase 2 study of dasatinib with hyper-CVAD for the frontline treatment of patients with Philadelphia chromosome-positive (Ph+) acute lymphoblastic leukemia. *Blood* 2010;116:2070-2077.
- ⁴Thomas DA, Faderl S, Cortes J, et al. Treatment of Philadelphia chromosome-positive acute lymphocytic leukemia with hyper-CVAD and imatinib mesylate. *Blood* 2004;103:4396-4407.
- ⁴Thomas DA, Kantarjian HM, Cortes J, et al. Outcome after frontline therapy with the hyper-CVAD and imatinib Mesylate Regimen for Adults with De Novo or Minimally Treated Philadelphia Chromosome (Ph) Positive Acute lymphoblastic leukemia (ALL) [abstract]. *Blood* 2008;112(Supple 11):Abstract 2931.
- ⁶Thomas DA, O'Brien SM, Faderl S, et al. Long-term outcome after hyper-CVAD and imatinib (IM) for de novo or minimally treated Philadelphia chromosome-positive acute lymphoblastic leukemia (Ph-ALL) [abstract]. *J Clin Oncol* 2010;28:Abstract 6506.
- ⁷Jabbour EJ, Kantarjian H, Ravandi F, et al. Combination of hyper-CVAD with ponatinib as first-line therapy for patients with Philadelphia chromosome-positive acute lymphoblastic leukaemia: a single-centre, phase 2 study. *Lancet Oncol*. 2015;16(15):1547-1555.
- ⁸Mizuta S, Matsuo K, Yagasaki F, et al. Pre-transplant imatinib-based therapy improves the outcome of allogeneic hematopoietic stem cell transplantation for BCR-ABL-positive acute lymphoblastic leukemia. *Leukemia* 2011;25:41-47.
- ⁹Yanada M, Takeuchi J, Sugiura I, et al. High complete remission rate and promising outcome by combination of imatinib and chemotherapy for newly diagnosed BCR-ABL-positive acute lymphoblastic leukemia: a phase II study by the Japan Adult Leukemia Study Group. *J Clin Oncol* 2006;24:460-466.
- ¹⁰Kim DY, Joo YD, Lim SN, et al. Nilotinib combined with multiagent chemotherapy for newly diagnosed Philadelphia-positive acute lymphoblastic leukemia. *Blood* 2015;126:746-756.
- ¹¹Vignetti M, Fazi P, Cimino G, et al. Imatinib plus steroids induces complete remissions and prolonged survival in elderly Philadelphia chromosome-positive patients with acute lymphoblastic leukemia without additional chemotherapy: results of the Gruppo Italiano Malattie Ematologiche dell'Adulto (GIMEMA) LAL0201-B protocol. *Blood* 2007;109:3676-3678.
- ¹²Foa R, Vitale A, Vignetti M, et al. Dasatinib as first-line treatment for adult patients with Philadelphia chromosome-positive acute lymphoblastic leukemia. *Blood* 2011;118:6521-6528.
- ¹³Chalandon Y, Thomas X, Hayette S, et al. Is less chemotherapy detrimental in adults with Philadelphia Chromosome (Ph)-positive acute lymphoblastic leukemia (ALL) treated with high-dose imatinib? Results of the Prospective Randomized Graaph-2005 Study [abstract]. *Blood* 2012;120:Abstract 138.
- ¹⁴Rousselot P, Coude MM, Huguet F, et al. Dasatinib and low intensity chemotherapy for first-line treatment in patients with de novo Philadelphia Positive ALL aged 55 and over: final results of the EWALL-Ph-01 study [abstract]. *Blood* 2012;120:Abstract 666.
- ¹⁵Stock W, Luger SM, Advani AS, et al: Favorable outcomes for older adolescents and young adults (AYA) with acute lymphoblastic leukemia (ALL): Early results of U.S. Intergroup Trial C10403. 2014 ASH Annual Meeting. Abstract 796. Presented December 9, 2014.
- ¹⁶Borowitz MJ, Wood BL, Devidas M, et al. Prognostic significance of minimal residual disease in high risk B-ALL: a report from Children's Oncology Group study AALL0232. *Blood* 2015;126:964-971
- ¹⁷Winter SS, Dunsmore KP, Devidas M, et al. Safe integration of nelarabine into intensive chemotherapy in newly diagnosed T-cell acute lymphoblastic leukemia: Children's Oncology Group Study AALL0434.
- ¹⁸DeAngelo DJ, Dahlberg S, Silverman LB, et al. A multicenter phase II study using a dose intensified pediatric regimen in adults with untreated acute lymphoblastic leukemia [abstract]. *Blood* 2007;110:Abstract 587.
- ¹⁹Huguet F, Leguay T, Raffoux E, et al. Pediatric-inspired therapy in adults with Philadelphia chromosome-negative acute lymphoblastic leukemia: the GRAALL-2003 study. *J Clin Oncol* 2009;27:911-918.
- ²⁰Ribera JM, Oriol A, Sanz MA, et al. Comparison of the results of the treatment of adolescents and young adults with standard-risk acute lymphoblastic leukemia with the Programa Espanol de Tratamiento en Hematologia pediatric-based protocol ALL-96. *J Clin Oncol* 2008;26:1843-1849.
- ²¹Thomas DA, O'Brien S, Faderl S, et al. Chemoimmunotherapy with a modified hyper-CVAD and rituximab regimen improves outcome in de novo Philadelphia chromosome-negative precursor B-lineage acute lymphoblastic leukemia. *J Clin Oncol* 2010;28:3880-3889.
- ²²Douer D, Aldoss I, Lunning MA, et al. Pharmacokinetics-based integration of multiple doses of intravenous pegaspargase in a pediatric regimen for adults with newly diagnosed acute lymphoblastic leukemia. *J Clin Oncol* 2014;32:905-911.
- ²³Linker C, Damon L, Ries C, Navarro W. Intensified and shortened cyclical chemotherapy for adult acute lymphoblastic leukemia. *J Clin Oncol* 2002;20:2464-2471.
- ²⁴Larson RA, Dodge RK, Burns CP, et al. A five-drug remission induction regimen with intensive consolidation for adults with acute lymphoblastic leukemia: cancer and leukemia group B study 8811. *Blood* 1995;85:2025-2037.
- ²⁵Kantarjian H, Thomas D, O'Brien S, et al. Long-term follow-up results of hyperfractionated cyclophosphamide, vincristine, doxorubicin, and dexamethasone (Hyper-CVAD), a dose-intensive regimen, in adult acute lymphocytic leukemia. *Cancer* 2004;101:2788-2801.
- ²⁶Rowe JM, Buck G, Burnett AK, et al. Induction therapy for adults with acute lymphoblastic leukemia: results of more than 1500 patients from the international ALL trial: MRC UKALL XII/ECOG E2993. *Blood*. 2005;106:3760-3767.
- ²⁷Lilly MB, Ottmann OG, Shah NP, et al. Dasatinib 140 mg once daily versus 70 mg twice daily in patients with Ph-positive acute lymphoblastic leukemia who failed imatinib: Results from a phase 3 study. *Am J Hematol* 2010;85:164-170.
- ²⁸Ottmann O, Dombret H, Martinelli G, et al. Dasatinib induces rapid hematologic and cytogenetic responses in adult patients with Philadelphia chromosome positive acute lymphoblastic leukemia with resistance or intolerance to imatinib: interim results of a phase 2 study. *Blood* 2014;110:2309-2315.
- ²⁹Ottmann OG, Druker BJ, Sawyers CL, et al. A phase 2 study of imatinib in patients with relapsed or refractory Philadelphia chromosome-positive acute lymphoid leukemias. *Blood* 2002;100:1965-71.
- ³⁰Cortes JE, Kim DW, Pinilla-Ibarz J, et al. A phase 2 trial of ponatinib in Philadelphia chromosome-positive leukemias. *N Engl J Med* 2013;369:1783-1796.
- ³¹Kantarjian H, Giles F, Wunderle L, et al. Nilotinib in imatinib-resistant CML and Philadelphia chromosome-positive ALL. *N Engl J Med* 2006;354:2542-2551.
- ³²Gambacorti-Passerini C, Kantarjian HM, Kim DW, et al. Long-term efficacy and safety of bosutinib in patients with advanced leukemia following resistance/intolerance to imatinib and other tyrosine kinase inhibitors. *Am J Hematol* 2015;90:755-768.
- ³³Martinelli G, Boissel N, Chevallier P, et al. Complete hematologic and molecular response in adult patients with relapsed/refractory Philadelphia Chromosome-positive B-Precursor acute lymphoblastic leukemia following treatment with blinatumomab: results from a phase II, single-arm, multicenter study. *J Clin Oncol* 2017.
- ³⁴Kadia TM, Kantarjian HM, Thomas DA, et al. Phase II study of methotrexate, vincristine, pegylated-asparaginase, and dexamethasone (MOPAD) in patients with relapsed/refractory acute lymphoblastic leukemia. *Am J Hematol* 2015;90:120-124.
- ³⁵Kantarjian H, Stein A, Gökbuğten N, et al. Blinatumomab versus chemotherapy for advanced acute lymphoblastic leukemia. *N Engl J Med* 2017;376: 836-847.
- ³⁶Weiss MA, Alif TB, Tallman MS, et al. A single, high dose of idarubicin combined with cytarabine as induction therapy for adult patients with recurrent or refractory acute lymphoblastic leukemia. *Cancer*. 2002;95:581-587.
- ³⁷Schiller G, Lee M, Territo M, Gajewski J, Nimer S. Phase II study of etoposide, ifosfamide, and mitoxantrone for the treatment of resistant adult acute lymphoblastic leukemia. *Am J Hematol* 1993;43:195-199.
- ³⁸DeAngelo DJ, Yu D, Johnson JL, et al. Nelarabine induces complete remissions in adults with relapsed or refractory T-lineage acute lymphoblastic leukemia or lymphoblastic lymphoma: Cancer and Leukemia Group B study 19801. *Blood* 2007;109:5136-5142.
- ³⁹Faderl S, Thomas DA, O'Brien S, et al. Augmented hyper-CVAD based on dose-intensified vincristine, dexamethasone, and asparaginase in adult acute lymphoblastic leukemia salvage therapy. *Clin Lymphoma Myeloma Leuk* 2011;11:54-59.
- ⁴⁰Deitcher OR, O'Brien S, Deitcher SR, et al. Single-agent vincristine sulfate liposomes injection (Marqibo®) compared to historical single-agent therapy for adults with advanced, relapsed and/or refractory Philadelphia chromosome negative acute lymphoblastic leukemia [abstract]. *Blood* 2011;118:Abstract 2592.
- ⁴¹O'Brien S, Schiller G, Lister J, et al. High-dose vincristine sulfate liposome injection for advanced, relapsed, and refractory adult Philadelphia chromosome-negative acute lymphoblastic leukemia. *J Clin Oncol* 2012;31:676-683.
- ⁴²Jeha S, Gaynon PS, Razzouk BI, et al. Phase II study of clofarabine in pediatric patients with refractory or relapsed acute lymphoblastic leukemia. *J Clin Oncol* 2006;24:1917-1923.
- ⁴³Miano M, Pistorio A, Putti MC, et al. Clofarabine, cyclophosphamide and etoposide for the treatment of relapsed or resistant acute leukemia in pediatric patients. *Leuk Lymphoma* 2012;53:1693-1698.

Note: All recommendations are category 2A unless otherwise indicated.

Clinical Trials: NCCN believes that the best management of any patient with cancer is in a clinical trial. Participation in clinical trials is especially encouraged.



NCCN Guidelines Version 1.2017

Acute Lymphoblastic Leukemia

PRINCIPLES OF SYSTEMIC THERAPY (5 of 5)

Treatment of Older Adults with ALL

Induction therapy for older adults with ALL (defined as aged 65 years and older) remains challenging. For those patients with advanced age, multiple comorbidities, and/or poor functional status, lower dose chemotherapy consisting of vincristine and steroids have effectively been used for decades. In older individuals with adequate functional status, intensive multi-agent chemotherapy regimens (such as hyper-CVAD and pediatric-inspired protocols) have been resulted in high remission rates. Despite this, many more older than younger ALL patients succumb to treatment-related mortality and morbidity, specifically myelosuppression and infectious complications. G-CSF does not ameliorate toxicity of these regimens thereby prompting the development of newer treatment regimens specifically for older patients, which include decreased drug doses and/or omission of some drugs. For instance, asparaginase has been removed from induction, and anthracycline doses have been reduced by 50% or omitted in some regimens. Similar to younger patients, MRD status appears to be a reliable predictor of clinical outcome following therapy. Whether rituximab improves upon chemotherapy in older adults with Ph-negative CD20+ ALL remains controversial. In contrast to younger patients, older patients with Ph-positive ALL may have improved overall survival and outcomes as compared with Ph-negative ALL due to the availability of well-tolerated, highly effective BCR-ABL1 TKI therapy. For appropriate fit individuals achieving remission, consideration of autologous or reduced-intensity allogeneic stem cell transplantation may be appropriate. See the [NCCN Guidelines for Older Adult Oncology](#). Discussion of ALL in the elderly can be found on OAO-B page 2 of 32.

INDUCTION REGIMENS for Ph-negative ALL – Adults aged ≥65 y

- Vincristine + prednisone¹ (Low intensity)
- Idarubicin + dexamethasone + vincristine + cyclophosphamide + cytarabine ± rituximab^{2,3} (Moderate intensity)
- HyperCVAD⁴ with dose-reduced cytarabine to 1 gm/m² (High intensity)
- CALGB 9111⁵ (High intensity)

INDUCTION REGIMENS for Ph-positive ALL – Adults aged ≥65 y

- TKI (imatinib, dasatinib) ± steroids⁶⁻⁸
- TKI (dasatinib) + vincristine + dexamethasone⁹
- TKI (imatinib) + steroids followed by multi-agent chemotherapy¹⁰

¹Hardisty RM, McElwain TJ, and Darby CW. Vincristine and prednisone for the induction of remissions in acute childhood leukaemia. *Br Med J* 1969;2:662-665.

²Gokbuget N, Beck J, Bruggemann M et al. Moderate intensive chemotherapy including CNS prophylaxis with liposomal cytarabine is feasible and effective in older patients with Ph-negative acute lymphoblastic leukemia (ALL): results of a prospective trial from the German multicenter study group for adult ALL (GMALL). *Blood* 2012;120:1493.

³Ribera JM, Garcia O, Oriol A et al. PETHEMA group: Feasibility and results of subtype-oriented protocols in older adults and fit patients with acute lymphoblastic leukemia: results of three prospective parallel trials from the PETHEMA group. *Leuk Res* 2016;41:12-20.

⁴O'Brien S, Thomas DA, Ravand F et al. Results of the hyperfractionated cyclophosphamide, vincristine, doxorubicin and dexamethasone in elderly patients with acute lymphocytic leukemia. *Cancer* 2008;113:2097-2101.

⁵Larson RA, Dodge RK, Linker CA et al. A randomized control trial of filgrastim during remission induction and consolidation chemotherapy for adults with acute lymphoblastic leukemia: CALGB 9111. *Blood* 1998;92:1556-1564.

⁶Ottmann OG, Wassmann B, Pfeiffer H et al. Imatinib compared with chemotherapy as front-line treatment of elderly patients with Ph-chromosome positive acute lymphoblastic leukemia. *Cancer* 2007;109:2068-2076.

⁷Foa R, Vitale A, Vignetti M, et al. Dasatinib as first-line treatment for adult patients with Philadelphia chromosome positive acute lymphoblastic leukemia. *Blood* 2011;118:6521-6528.

⁸Vignetti M, Fazi P, Cimino G et al. Imatinib plus steroids induces complete remissions and prolonged survival in elderly Philadelphia chromosome positive patients with acute lymphoblastic leukemia without additional chemotherapy: results of the Gruppo Italiano Malattie Ematologiche dell'Adulto (GIMEMA) LAL0201-B protocol. *Blood* 2007;109:3676-3678.

⁹Rousselot P, Coude MM, Gokbuget N et al. Dasatinib and low-intensity chemotherapy in elderly patients with Philadelphia chromosome-positive ALL. *Blood* 2016;128:774-82.

¹⁰Delannoy A, Delabesse E, Lheritier V et al. Imatinib and methylprednisolone alternated with chemotherapy improve the outcome of elderly patients with Philadelphia-positive acute lymphoblastic leukemia: results of the GRAALL AFR09 study. *Leukemia* 2006;20:1526-1532.

Note: All recommendations are category 2A unless otherwise indicated.

Clinical Trials: NCCN believes that the best management of any patient with cancer is in a clinical trial. Participation in clinical trials is especially encouraged.



RESPONSE ASSESSMENT

Response Criteria for Blood and Bone Marrow:

- **CR**
 - ▶ **No circulating blasts or extramedullary disease**
 - ◇ **No lymphadenopathy, splenomegaly, skin/gum infiltration/testicular mass/CNS involvement**
 - ▶ **Trilineage hematopoiesis (TLH) and <5% blasts**
 - ▶ **Absolute neutrophil count (ANC) >1000/microL**
 - ▶ **Platelets >100,000/microL**
 - ▶ **No recurrence for 4 weeks**
- **CR with incomplete blood count recovery (CRi)**
 - ▶ **Meets all criteria for CR except platelet count and/or ANC**
- **Overall response rate (ORR = CR + CRi)**
- **Refractory disease**
 - ▶ **Failure to achieve CR at the end of induction**
- **Progressive disease (PD)**
 - ▶ **Increase of at least 25% in the absolute number of circulating or bone marrow blasts or development of extramedullary disease**
- **Relapsed disease**
 - ▶ **Reappearance of blasts in the blood or bone marrow (>5%) or in any extramedullary site after a CR**

Response Criteria for CNS Disease:

- **CNS remission: Achievement of CNS-1 status ([see ALL-B](#)) in a patient with CNS-2 or CNS-3 status at diagnosis.**
- **CNS relapse: New development of CNS-3 status or clinical signs of CNS leukemia such as facial nerve palsy, brain/eye involvement, or hypothalamic syndrome.**

Response Criteria for Lymphomatous Extramedullary Disease:

- **CT of neck/chest/abdomen/pelvis with IV contrast and PET/CT should be performed to assess response for extramedullary disease.**
- **CR: Complete resolution of lymphomatous enlargement by CT. For patients with a previous positive PET scan, a post-treatment residual mass of any size is considered a CR as long as it is PET negative.**
- **PR: >50% decrease in the sum of the product of the greatest perpendicular diameters (SPD) of the mediastinal enlargement. For patients with a previous positive PET scan, post-treatment PET must be positive in at least one previously involved site.**
- **PD: >25% increase in the SPD of the mediastinal enlargement. For patients with a previous positive PET scan, post-treatment PET must be positive in at least one previously involved site.**
- **No Response (NR): Failure to qualify for PR or PD.**
- **Relapse: Recurrence of mediastinal enlargement after achieving CR. For patients with a previous positive PET scan, post-treatment PET must be positive in at least one previously involved site.**

Note: All recommendations are category 2A unless otherwise indicated.

Clinical Trials: NCCN believes that the best management of any patient with cancer is in a clinical trial. Participation in clinical trials is especially encouraged.



MINIMAL RESIDUAL DISEASE ASSESSMENT

- The optimal sample for MRD assessment is the first pull or early pull of the bone marrow aspirate.
- MRD in ALL refers to the presence of leukemic cells below the threshold of detection by conventional morphologic methods. Patients who achieved a CR by morphologic assessment alone can potentially harbor a large number of leukemic cells in the bone marrow.
- MRD is an essential component of patient evaluation over the course of sequential therapy. If patient is not treated in an academic center, there are commercially available tests available that should be used for MRD assessment.
- Studies in both children and adults with ALL have demonstrated the strong correlation between MRD and risks for relapse, as well as the prognostic significance of MRD measurements during and after initial induction therapy.
- The most frequently employed methods for MRD assessment include multicolor flow cytometry assays specifically designed to detect abnormal MRD immunophenotypes, real-time quantitative polymerase chain reaction (RQ-PCR) assays, and next-generation sequencing-based assays to detect fusion genes (eg, *BCR-ABL1*), clonal rearrangements in immunoglobulin (Ig) heavy chain genes, and/or T-cell receptor (TCR) genes.
- Current multicolor flow cytometry or PCR methods can detect leukemic cells at a sensitivity threshold of $<1 \times 10^{-4}$ ($<0.01\%$) bone marrow mononuclear cells (MNCs).^{1,2} The concordance rate for detecting MRD between these methods is generally high.
 - ▶ Timing of MRD assessment:
 - ◇ Upon completion of initial induction.
 - ◇ Additional time points should be guided by the regimen used.

¹Bruggemann M, Schrauder A, Raff T, et al. Standardized MRD quantification in European ALL trials: proceedings of the Second International Symposium on MRD assessment in Kiel, Germany, 18-20 September 2008. *Leukemia* 2010;24:521-535.

²Campana D. Minimal residual disease in acute lymphoblastic leukemia. *Hematology Am Soc Hematol Educ Program* 2010;2010:7-12.

Note: All recommendations are category 2A unless otherwise indicated.

Clinical Trials: NCCN believes that the best management of any patient with cancer is in a clinical trial. Participation in clinical trials is especially encouraged.

Discussion

This discussion is being updated to correspond with the newly updated algorithm. Last updated 09/29/16

NCCN Categories of Evidence and Consensus

Category 1: Based upon high-level evidence, there is uniform NCCN consensus that the intervention is appropriate.

Category 2A: Based upon lower-level evidence, there is uniform NCCN consensus that the intervention is appropriate.

Category 2B: Based upon lower-level evidence, there is NCCN consensus that the intervention is appropriate.

Category 3: Based upon any level of evidence, there is major NCCN disagreement that the intervention is appropriate.

All recommendations are category 2A unless otherwise noted.

Table of Contents

Overview.....	MS-2
Literature Search Criteria and Guidelines Update Methodology.....	MS-3
Diagnosis.....	MS-3
Clinical Presentation and Diagnosis.....	MS-3
Immunophenotyping.....	MS-4
Cytogenetic and Molecular Subtypes.....	MS-5
Workup.....	MS-6
Table 1. Common Chromosomal and Molecular Abnormalities in ALL.....	MS-7
Prognostic Factors and Risk Stratification.....	MS-7
Prognostic Factors in AYA Patients with ALL.....	MS-8
Prognostic Factors in Adults with ALL.....	MS-9
NCCN Recommendations for Risk Assessment in ALL.....	MS-10
Overview of Treatment Phases in ALL Management.....	MS-11

Induction.....	MS-11
CNS Prophylaxis and Treatment.....	MS-12
Consolidation.....	MS-12
Maintenance.....	MS-12
Targeted Agents.....	MS-13
Management of Ph-Positive ALL.....	MS-14
Initial Treatment in AYA Patients with Ph-Positive ALL.....	MS-14
Initial Treatment in Adults with Ph-Positive ALL.....	MS-17
Treatment of Relapsed Ph-Positive ALL.....	MS-20
NCCN Recommendations for Ph-Positive ALL.....	MS-24
Patients with Relapsed/Refractory Ph-Positive ALL.....	MS-25
Management of Ph-Negative ALL.....	MS-26
Initial Treatment in AYAs with Ph-Negative ALL.....	MS-26
Initial Treatment in Adults with Ph-Negative ALL.....	MS-32
Treatment of Relapsed Ph-Negative ALL.....	MS-33
NCCN Recommendations for Ph-Negative ALL.....	MS-39
Management of Lymphoblastic Lymphoma.....	MS-40
Evaluation and Treatment of Extramedullary Disease.....	MS-41
CNS Involvement in ALL.....	MS-41
NCCN Recommendations for Evaluation and Treatment of MS-Extramedullary Involvement.....	MS-42
Response Assessment and Surveillance.....	MS-43
Response Criteria.....	MS-43
Surveillance.....	MS-43
Role of MRD Evaluation.....	MS-44
MRD Assessment in Childhood ALL.....	MS-44
MRD Assessment in Adult ALL.....	MS-47
NCCN Recommendations for MRD Assessment.....	MS-49
Supportive Care for Patients with ALL.....	MS-50
NCCN Recommendations for Supportive Care.....	MS-50
References.....	MS-55

Overview

The NCCN Clinical Practice Guidelines in Oncology (NCCN Guidelines®) for Acute Lymphoblastic Leukemia (ALL) were developed as a result of meetings convened by a multidisciplinary panel of ALL experts, with the goal of providing recommendations on standard treatment approaches based on current evidence. The NCCN Guidelines focus on the classification of ALL subtypes based on immunophenotype and cytogenetic/molecular markers; risk assessment and stratification for risk-adapted therapy; treatment strategies for Philadelphia chromosome (Ph)-positive and Ph-negative ALL for both adolescent and young adult (AYA) and adult patients; and supportive care considerations. Given the complexity of ALL treatment regimens and the required supportive care measures, the NCCN ALL Panel recommends that patients be treated at a specialized cancer center with expertise in the management of ALL.

ALL is a heterogeneous hematologic disease characterized by the proliferation of immature lymphoid cells in the bone marrow, peripheral blood, and other organs.¹ The age-adjusted incidence rate of ALL in the United States is 1.58 per 100,000 individuals per year,² with approximately 6590 new cases and 1430 deaths estimated in 2016.³ The median age at diagnosis for ALL is 15 years⁴ with 57.2% of patients diagnosed at younger than 20 years of age.⁵ In contrast, 26.8% of cases are diagnosed at 45 years or older and only approximately 11% of patients are diagnosed at 65 years or older.⁵ ALL represents 75% to 80% of acute leukemias among children, making it the most common form of childhood leukemia; by contrast, ALL represents approximately 20% of all leukemias among adults.^{1,6}

Risk factors for developing ALL include older age (>70 years), exposure to chemotherapy or radiation therapy, and genetic disorders, particularly

Down syndrome.^{7,8} Although rare, other genetic conditions have been categorized as a risk factor for ALL and include neurofibromatosis,⁹ Klinefelter syndrome,¹⁰⁻¹² Fanconi anemia,^{13,14} Shwachman-Diamond syndrome,^{15,16} Bloom syndrome,¹⁷ and ataxia telangiectasia.¹⁸

The cure rates and survival outcomes for patients with ALL have improved dramatically over the past several decades, primarily among children. Improvements are largely owed to advances in the understanding of the molecular genetics and pathogenesis of the disease, the incorporation of risk-adapted therapy, and the advent of new targeted agents. Data from the SEER database have shown a 5-year overall survival (OS) of 86% to 89% for children;^{19,20} however, AYA patients were reported to have a 5-year OS between 42% to 63% depending on the age range. Adults have the poorest 5-year OS rate of 24.1% for patients between the ages of 40 and 59 and an even lower rate of 17.7% for patients between the ages of 60 and 69.²¹ Although the exact OS percentage can vary based on how the age range is defined for pediatric, AYA, and adult patients, the trend is nonetheless clear that OS decreases substantially with increased age. The exception is infants younger than age 1, which is an age group that has not seen any improvement in survival over the last 30 years. The 5-year OS in this population is 55.8%¹⁹ (see *Cytogenetic and Molecular Subtypes*). Cure rates for AYAs with ALL remain suboptimal compared with those for children, although substantial improvements have been seen with the recent adoption of pediatric treatment regimens.²² AYA patients represent a unique population, because they may receive treatment based on either a pediatric or an adult protocol, depending on local referral patterns and institutional practices. Favorable cytogenetic subtypes, such as *ETV6-RUNX1* ALL and hyperploidy, occur less frequently among AYA patients compared with children, whereas the

incidence of ALL with *BCR-ABL* (Ph-positive ALL) is higher in AYA patients.

Literature Search Criteria and Guidelines Update Methodology

Prior to the update of this version of the NCCN Guidelines for Acute Lymphoblastic Leukemia, an electronic search of the PubMed database was performed to obtain key literature published between December 3, 2014 and December 10, 2015, using the following search term: acute lymphoblastic leukemia. The PubMed database was chosen as it remains the most widely used resource for medical literature and indexes only peer-reviewed biomedical literature.²³

The search results were narrowed by selecting studies in humans published in English. Results were confined to the following article types: Clinical Trial, II; Clinical Trial, III; Clinical Trial, IV; Guideline; Meta-Analysis; Randomized Controlled Trial; Systematic Reviews; and Validation Studies.

The PubMed search resulted in 39 citations and their potential relevance was examined. The data from key PubMed articles as well as articles from additional sources deemed as relevant to these Guidelines and discussed by the panel have been included in this version of the Discussion section (eg, e-publications ahead of print, meeting abstracts). Recommendations for which high-level evidence is lacking are based on the panel's review of lower-level evidence and expert opinion.

The complete details of the Development and Update of the NCCN Guidelines are available on the NCCN [webpage](#).

Diagnosis

Clinical Presentation and Diagnosis

The clinical presentation of ALL is typically nonspecific, and may include fatigue or lethargy, constitutional symptoms (eg, fevers, night sweats, weight loss), dyspnea, dizziness, infections, and easy bruising or bleeding.^{1,24} Among children, pain in the extremities or joints may be the only presenting symptom.¹ The presence of lymphadenopathy, splenomegaly, and/or hepatomegaly on physical examination may be found in approximately 20% of patients. Abdominal masses from gastrointestinal involvement, or chin numbness resulting from cranial nerve involvement, are more suggestive of mature B-cell ALL.^{1,24}

The diagnosis of ALL generally requires demonstration of 20% or greater bone marrow lymphoblasts on hematopathology review of bone marrow aspirate and biopsy materials. The 2008 WHO classification lists ALL and lymphoblastic lymphoma as the same entity, distinguished only by the primary location of the disease.^{25,26} When the disease is restricted to a mass lesion primarily involving nodal or extranodal sites with no or minimal involvement in blood or bone marrow (generally defined as <20% lymphoblasts in the marrow), the case would be consistent with a diagnosis of lymphoblastic lymphoma.^{25,26}

Lymphoblastic lymphoma was previously categorized with non-Hodgkin's lymphoma and is associated with exposure to radiation or pesticide and congenital or acquired immunosuppression. However, based on morphologic, genetic, and immunophenotypic features, lymphoblastic lymphoma is indistinguishable from ALL. Patients with lymphoblastic lymphoma generally benefit from treatment with ALL-like regimens and should be treated in a center that has experience with lymphoblastic lymphoma (see *Management of Lymphoblastic Lymphoma*).



NCCN Guidelines Version 1.2017

Acute Lymphoblastic Leukemia

Hematopathology evaluations should include morphologic examination of malignant lymphocytes using Wright-Giemsa–stained slides and hematoxylin and eosin–stained core biopsy and clot sections; comprehensive immunophenotyping with flow cytometry (see *Immunophenotyping*); and assessment of cytogenetic or molecular abnormalities. Identification of specific recurrent genetic abnormalities is critical for disease evaluation, optimal risk stratification, and treatment planning (see *Cytogenetic and Molecular Subtypes*). Subtypes of B-cell ALL with recurrent genetic abnormalities include the following: hyperdiploidy (51–65 chromosomes); hypodiploidy (<44 chromosomes); t(9;22)(q34;q11.2), *BCR-ABL1*; t(4;11) and other *MLL rearranged*, t(v;11q23); t(12;21)(p13;q22), *ETV6-RUNX1*; t(1;19)(q23;p13.3), *TCF3-PBX1*; and t(5;14)(q31;q32), *IL3-IGH*.²⁷ Presence of recurrent genetic abnormalities should be evaluated using karyotyping of G-banded metaphase chromosomes (conventional cytogenetics) and/or interphase fluorescence in situ hybridization (FISH) assays that include probes capable of detecting the genetic abnormalities.

Immunophenotyping

Immunophenotypic classification of ALL involves flow cytometry to determine the presence of cell surface antigens on lymphocytes. ALL can be broadly classified into 3 groups based on immunophenotype, which include precursor B-cell ALL, mature B-cell ALL, and T-cell ALL.^{1,28} Among children, B-cell lineage ALL constitutes approximately 88% of cases;²⁹ in adult patients, subtypes of B-cell lineage ALL represent approximately 75% of cases (including mature B-cell ALL that constitutes 5% of adult ALL), whereas the remaining 25% comprise T-cell lineage ALL.^{29,30} Within the B-cell lineage, the profile of cell surface markers differs according to the stage of B-cell maturation, which includes early precursor B-cell (early pre-B-cell), pre-B-cell, and mature B-cell ALL. Early pre-B-cell ALL is characterized by the presence of terminal deoxynucleotidyl transferase (TdT), the expression of

CD19/CD22/CD79a, and the absence of CD10 (formerly termed *common ALL antigen*) or surface immunoglobulins. Pre-B-cell ALL is characterized by the presence of cytoplasmic immunoglobulins and CD10/CD19/CD22/CD79a expression^{1,24,25,30} and was previously termed common B-cell ALL due to the expression of CD10 at diagnosis. Mature B-cell ALL shows positivity for surface immunoglobulins and clonal lambda or kappa light chains, and is negative for TdT.¹ CD20 may be expressed in approximately 50% of B-cell lineage ALL in adults, with a higher frequency (>80%) observed in cases of mature B-cell ALL.^{31,32}

T-cell lineage ALL is typically associated with the presence of cytoplasmic CD3 (T-cell lineage blasts) or cell surface CD3 (mature T-cells) in addition to variable expression of CD1a/CD2/CD5/CD7 and expression of TdT.^{1,24,26} CD52 may be expressed in 30% to 50% of T-cell lineage ALL in adults.¹ Combined data from the GMALL 06/99 study and the GMALL 07/03 study revealed a distribution of T-cell lineage ALL among three subgroups: cortical/thymic (56%), medullary/mature (21%), and early (23%) T-cell ALL.²⁸ The latter is further divided between early T-cell precursor (ETP) ALL and early immature T-ALL. Early immature T-ALL includes both pro-T-ALL and pre-T-ALL immunophenotypes (for specific markers, see *Typical Immunophenotype by Major ALL Subtypes* in the algorithm).

ETP ALL represents a distinct biologic subtype of T-cell lineage ALL that accounts for 12% of pediatric T-ALLs (and about 2% of ALL), and is associated with poor clinical outcomes even with contemporary treatment regimens. This subtype is characterized by the absence of CD1a/CD8, weak expression of CD5 (<75% positive lymphoblasts), and the presence of 1 or more myeloid or stem cell markers (CD117, CD34, HLA-DR, CD13, CD33, CD11b, or CD65) on at least 25% of lymphoblasts.³³ In a study of 239 patients with T-ALL, gene expression profiling, flow cytometry, and single nucleotide polymorphism array

analysis were employed to identify patients with ETP-ALL.³³ ETP-ALL was associated with a 10-year OS of 19% (95% CI, 0%–92%) compared with 84% (95% CI, 72%–96%) in the non-ETP-ALL patients. The 10-year event-free survival (EFS) was similarly poor in patients with ETP-ALL (22%; 95% CI, 5%–49%) compared with non-ETP-ALL patients (69%; 95% CI, 53%–84%). Remission failure and hematologic relapse were significantly higher for patients with ETP-ALL ($P < .0001$).³³ A pivotal study from Zhang et al³⁴ identified a high frequency of activating mutations in the cytokine receptor and RAS signaling pathways that included *NRAS*, *KRAS*, *FLT3*, *IL7R*, *JAK3*, *JAK1*, *SH2B3*, and *BRAF*. Furthermore, inactivating mutations of genes that encode hematopoietic developmental transcription factors, including *GATA3*, *ETV6*, *RUNX1*, *IKZF1*, and *EP300*, were observed. These mutations are more frequent in myeloid neoplasms than in other subtypes of ALL, suggesting that myeloid-derived therapies and targeted therapy may be better treatment options for select ALL subtypes. The data indicate a need for alternative treatments to standard intensive chemotherapy in this subpopulation. Due to the nature of ETP-ALL, myeloablative therapy followed by HCT in first remission may be an alternative. This regimen had previously demonstrated superior results for patients with T-ALL and poor early responses.³⁵

Hematologic malignancies related to ALL include acute leukemias with ambiguous lineage, such as the mixed phenotype acute leukemias (MPALs). MPALs include bilineage leukemias, in which 2 distinct populations of lymphoblasts are identified, with 1 meeting the criteria for acute myeloid leukemia. Biphenotypic MPAL is defined as a single population of lymphoblasts that expresses markers consistent with B-cell or T-cell ALL, in addition to expressing myeloid or monocytic markers. Notably, myeloid-associated markers such as CD13 and CD33 may be expressed in ALL, and the presence of these markers does not exclude this diagnosis, nor is it associated with adverse prognosis.^{25,26}

The identification of mixed lineage leukemias should follow the criteria presented in the 2008 WHO classification of neoplasms. The initial immunophenotyping panel should be sufficiently comprehensive to establish a leukemia-associated phenotype that may include expression of nonlineage antigens; these are useful in classification, particularly for MPAL.

Cytogenetic and Molecular Subtypes

Recurrent chromosomal and molecular abnormalities characterize ALL subtypes in both adults and children (Table 1), and often provide prognostic information that may weigh into risk stratification and treatment decisions. The frequency of certain subtypes differs between adult and childhood ALL, which partially explains the difference in clinical outcomes between patient populations. Among children with ALL, the most common chromosomal abnormality is hyperdiploidy (>50 chromosomes; 25% of cases) seen in B-cell lineage ALL compared to 7% in the adult ALL patient population.^{29,36} The *ETV6-RUNX1* subtype (also within the B-cell lineage) resulting from chromosomal translocation t(12;21) is among the most commonly occurring subtypes in childhood ALL (22%) compared to adults (2%).²⁹ Both hyperdiploidy and *ETV6-RUNX1* subtypes are associated with favorable outcomes in ALL.³⁶⁻³⁸ Ph-positive ALL, associated with poor prognosis, is relatively uncommon among childhood ALL (3%), whereas this abnormality is the most common subtype among adults (25%).²⁹ The frequency of Ph-positive ALL increases with age (10%, patients 15–39 years; 25%, patients 40–49 years; 20%–40%, patients >50 years).^{37,39-41} Moreover, younger children (1–9 years) with Ph-positive ALL have a better prognosis than adolescents with this subtype.⁴²

Philadelphia-like (Ph-like) ALL is a subgroup of B-cell lineage ALL associated with unfavorable prognosis.^{43,44} Similar to Ph-positive ALL, the 5-year disease-free survival (DFS) in this population is estimated to

be 60%;⁴³ however, this genotype is 4 to 5 times more frequent in children and young adults than the Ph-positive ALL phenotype. Although this subgroup is Ph-negative, there is an otherwise similar genetic profile to the Ph-positive ALL subgroup including mutation of the *IKZF1* gene. Genomically, this subtype is further identified by mutations in the Ras and JAK/STAT5 pathways as the common mechanism of transformation. These include mutations in the *ABL1*, *EPOR*, *JAK2*, *PDGFRβ*, *EBF1*, *FLT2*, *IL7R*, and *SH2B3* genes.⁴³⁻⁴⁵ A recent publication found kinase-activating alternations in 91% of Ph-like ALL cases.⁴⁶ Therefore, use of the ABL1 tyrosine kinase inhibitor (TKI) imatinib or other targeted therapies may significantly improve patient outcomes in this subgroup.

Other cytogenetic and molecular subtypes are associated with ALL and prognosis. Although not as common, translocations in the *MLL* gene [in particular, cases with t(4;11) translocation] are known to have poor prognosis.^{22,31} Hypodiploidy is associated with poor prognosis and is observed in 1% to 2% of patients.^{22,47} Low hypodiploidy (30–39 chromosomes)/near triploidy (60–68 chromosomes) and complex karyotype (≥5 chromosome abnormalities) are also associated with poor prognosis, and occur more frequently with increasing age (1%–3%, patients 15–29 years; 3%–6%, patients 30–59 years; 5%–11%, patients >60 years).³⁷

In B-cell ALL, mutations in the Ikaros gene (*IKZF1*) are associated with a poor prognosis and a greater incidence of relapse. *IKZF1* mutations are seen in approximately 15% to 20% of pediatric B-cell ALL^{48,49} and at a higher frequency of greater than 75% in patients who are also BCR-ABL positive.^{44,49} Incidence in adults is about 50% in B-cell ALL^{50,51} and about 65% in patients who are BCR-ABL positive.^{52,53} A study evaluating the relationship between BCR-ABL1-like and *IKZF1* in children with B-cell precursor ALL showed that 40% of cases had co-

occurrence of these mutations.⁵⁴ The presence of either mutation was indicative of poor prognosis and was independent of conventional risk factors. Both mutations are considered strong independent risk factors for B-cell ALL and are applicable across a broad range of stratified ALL including patients with intermediate minimal residual disease (MRD). The DCOG ALL-11 trial will incorporate *IKZF1* as a risk factor and patients will receive an additional year of maintenance therapy if *IKZF1* is detected. However, despite the prognostic value and potential for risk stratification based on the presence of *IKZF1* mutations⁵⁵, there are no suitable testing methods for these mutations, thereby limiting current clinical applications.

Workup

The initial workup for patients with ALL should include a thorough medical history and physical examination, along with laboratory and imaging studies (where applicable). Laboratory studies include a complete blood count (CBC) with platelets and differential, a blood chemistry profile, a disseminated intravascular coagulation panel (including measurements for D-dimer, fibrinogen, prothrombin time, and partial thromboplastin time), and a tumor lysis syndrome (TLS) panel (including measurements for serum lactate dehydrogenase [LDH], uric acid, potassium, phosphates, and calcium). Procurement of cells should be considered for purposes of future research (in accordance with institutional practices or policies). All male patients should be evaluated for testicular involvement of disease; testicular involvement is especially common in cases of T-cell ALL. For patients with T-cell ALL, CT scans of the chest with IV contrast are warranted. For patients with a mediastinal mass, baseline PET imaging is also recommended.

Table 1. Common Chromosomal and Molecular Abnormalities in ALL

Cytogenetics	Gene	Frequency in Adults	Frequency in Children
Hyperdiploidy (>50 chromosomes)	--	7%	25%
Hypodiploidy (<44 chromosomes)	--	2%	1%
t(9;22)(q34;q11): Philadelphia chromosome (Ph)	<i>BCR-ABL1</i>	25%	2%–4%
t(12;21)(p13;q22)	<i>ETV6-RUNX1 (TEL-AML1)</i>	2%	22%
t(v;11q23) [eg, t(4;11), t(9;11)], t(11;19)	<i>MLL</i>	10%	8%
t(1;19)(q23;p13)	<i>TCF3-PBX1 (E2A-PBX1)</i>	3%	6%
t(5;14)(q31;q32)	<i>IL3-IGH</i>	<1%	<1%
t(8;14), t(2;8), t(8;22)	<i>c-MYC</i>	4%	2%
t(1;14)(p32;q11)	<i>TAL-1^a</i>	12%	7%
t(10;14)(q24;q11)	<i>HOX11 (TLX1)^a</i>	8%	1%
t(5;14)(q35;q32)	<i>HOX11L2^a</i>	1%	3%
t(11;14)(q11) [eg, (p13;q11), (p15;q11)]	<i>TCRα and TCRδ</i>	20%–25%	10%–20%
BCR-ABL1-like	<i>various^b</i>	10%–30%	15%
ETP	<i>various^a</i>	2%	2%
Ikaros	<i>IKZF1</i>	50%	12%–17%

^aAbnormalities observed exclusively in T-cell lineage ALL; all others occur exclusively or predominately in B-cell lineage ALL. ^bSee text for more details.

All patients should be evaluated for infections, including screening for active infections if febrile or for symptomatic opportunistic infections. Empiric anti-infective therapy should be initiated, as appropriate (see NCCN Guidelines for Prevention and Treatment of Cancer-Related Infections). In addition, an echocardiogram or cardiac scan should be considered for all patients due to the use of anthracyclines as the backbone of nearly all treatment regimens. Assessment of cardiac function is particularly important for patients with prior cardiac history,

prior anthracycline exposure, or clinical symptoms suggestive of cardiac dysfunction, and for elderly patients. Except in patients with major contraindications to hematopoietic cell transplantation (HCT), human leukocyte antigen (HLA) typing should be performed at workup. Additionally, an early evaluation and search for alternative donors should be considered.

Appropriate imaging studies (eg, CT/MRI scan of the head with contrast) should be performed to detect meningeal disease, chloromas, or central nervous system (CNS) bleeding for patients with major neurologic signs or symptoms at diagnosis. CNS involvement should be evaluated through lumbar puncture at timing that is consistent with the treatment protocol. Pediatric-inspired regimens typically include lumbar puncture at diagnostic workup; however, the NCCN ALL Panel recommends that lumbar puncture, if performed, be done concomitantly with initial intrathecal therapy (see *NCCN Recommendations for Evaluation and Treatment of Extramedullary Involvement*).

It should be noted that the recommendations included in the guidelines represent a minimum set of workup considerations, and that other evaluations or testing may be needed based on clinical symptoms.

Prognostic Factors and Risk Stratification

Various disease-related and patient-specific factors may have prognostic significance in patients with ALL. In particular, patient age, white blood cell (WBC) count, immunophenotypic/cytogenetic subtype, presence of CNS disease, and response to induction therapy have been identified as important factors in defining risk and assessing prognosis for both adult and childhood ALL.

Prognostic Factors in AYA Patients with ALL

Initially, risk assessment for childhood ALL was individually determined by the institution, complicating the interpretation of data. However, in 1993, a common set of risk criteria was established by the Pediatric Oncology Group (POG) and Children's Cancer Study Group (CCG) at an international conference hosted by the NCI.⁵⁶ In this system, two risk groups were designated: standard risk and high risk. Standard risk was assigned to patients age 1 to younger than 10 years of age and with a WBC count less than 50×10^9 cells/L, whereas all other patients with ALL, including T-cell ALL (regardless of age or WBC count), were considered high risk.⁴⁷ It should be noted that despite exclusion from this report, patients younger than age 1 should also be considered very high risk. The POG and CCG have since merged to form the Children's Oncology Group (COG) and subsequent risk assessment has produced additional risk factors, particularly in precursor B-cell ALL, to further refine therapy. Specifically, in B-cell ALL, a group identified as very high risk was defined as patients with any of the following characteristics: t(9;22) chromosomal translocation (ie, Ph-positive ALL), and/or presence of BCR-ABL fusion protein; hypodiploidy (<44 chromosomes);⁵⁷ or failure to achieve remission with induction therapy.^{22,47} MLL rearrangements and a poor response to induction chemotherapy also re-categorized patients into this group.⁵⁸⁻⁶⁰ Conversely, criteria were refined for lower risk and included patients with hyperploidy, the t(12;21) chromosomal translocation (*ETV6-RUNX1* subtype),⁶¹ or simultaneous trisomies of chromosomes 4, 10, and 17.^{47,62} Presence of extramedullary disease and the early response to treatment also modified risk. Early marrow response to therapy was a strong positive prognostic factor while the presence of extramedullary disease at diagnosis was correlated with a poorer prognosis. Using the refined risk assessment, four risk categories for B-cell ALL, designated

as low risk, standard risk, high risk, and very high risk were identified encompassing 27%, 32%, 27%, and 4% of cases, respectively.⁴⁷

Risk stratification of T-cell ALL has been more difficult than in B-cell ALL. Although T-cell ALL is often categorized as very high risk depending on the institute, newer treatment options have resulted in improved survival outcomes for these patients. Furthermore, the identification of genetic mutations and the use of targeted therapies may change the way T-cell ALL is treated and ultimately how these patients are assessed for risk.

Historically, the AYA population has been treated on either a pediatric or an adult ALL regimen, depending on referral patterns and the institution. In recent years, several retrospective studies from both the United States and Europe have shown that AYA patients (15–21 years of age) treated on a pediatric protocol have substantially improved EFS compared to same-aged patients treated on adult ALL regimens.^{22,38} Comparison of adult and pediatric protocols has shown that adults received lower doses of nonmyelosuppressive chemotherapy and less intense intrathecal chemotherapy regimens.^{63,64} Adult protocols also entail a greater use of allogeneic HCT compared to pediatric protocols, but the benefits of HCT in the AYA population have not been sufficiently studied, and the available data have conflicting findings.⁶⁵⁻⁶⁹ However, this is a significant difference between the way adults and pediatric patients are treated and may be a variable in the treatment of AYA patients. Thus, the choice of initial treatment regimen can have a profound impact on overall clinical outcomes in AYA patients.

Despite improved outcomes for AYA patients treated on pediatric-inspired regimens versus adult ALL regimens, studies have shown poorer outcomes among patients in the AYA group compared with children younger than 10 years.⁷⁰ This may be attributed to factors that

are based on biology and social differences. Compared to the pediatric population, AYA patients have a lower frequency of favorable chromosomal/cytogenetic abnormalities, such as hyperdiploidy or *ETV6-RUNX1*⁷¹ and a greater incidence of poor-risk cytogenetics including Ph-positive ALL, hypodiploidy, and complex karyotype,⁷² and a higher incidence of ETP-ALL.^{33,73} Furthermore, the positive prognostic values of the *ETV6-RUNX1* mutation and hyperdiploidy are greater in the pediatric population, suggesting that the benefits decline with age.⁷² The effects of the treatment are also shown to be different in the AYA population compared to the pediatric population. In vitro studies showed that ALL cells from children older than 10 years are more resistant to chemotherapy compared to the cells from children younger than 10 years.⁷⁴ The COG AALL0232 study reported an initial delay in response to induction therapy in older AYA patients (ages 16–30 years) compared to younger patients (1–15 years).⁷⁵ There was a statistically significant reduction in the number of patients in the older cohort who had negative end-induction MRD compared to the younger cohort (59% vs. 74%; $P < .0001$) with fewer patients achieving M1 marrow on day 15 of induction (67% vs. 80%, respectively; $P = .0015$). In addition to the biological differences, the social component of treating AYA patients is important. Enrollment in clinical trials has been shown to improve patient outcomes;⁷⁶ however, only 2% of AYA patients enroll in clinical trials compared to the 60% enrollment of pediatric patients.⁷⁷ Pediatric patients have been shown to be more compliant to treatment protocols compared to AYA patients,⁷⁸ which may be due to greater parental supervision of the treatment and better insurance.⁷⁹

Prognostic Factors in Adults with ALL

Both age and initial WBC count have historically been considered clinically significant prognostic factors in the management of adult patients with ALL.^{28,31} Early prospective multicenter studies defined

values for older age (>35 years) and higher initial WBC count (>30 × 10⁹/L for B-cell lineage; >100 × 10⁹/L for T-cell lineage) that were predictive of significantly decreased remission duration.^{80,81} Subsequent studies have confirmed the prognostic importance of these clinical parameters, although the cutoff values differed between studies.^{28,31}

In one of the largest studies to date (n = 1521) conducted by the Medical Research Council (MRC) UKALL/ECOG, both age (>35 years) and WBC count (>30 × 10⁹/L for B-cell lineage; >100 × 10⁹/L for T-cell lineage) were found to be significant independent prognostic factors for decreased DFS and OS among patients with Ph-negative ALL; the independent prognostic value remained significant when these factors were evaluated as continuous variables in multivariate analysis.⁸² All patients, regardless of Ph status, had received induction therapy followed by intensification (for patients with a complete response [CR] postinduction) with contemporary chemotherapy combination regimens. Patients with a CR after induction received allogeneic HCT (for patients <50 years of age and with HLA-compatible siblings), autologous HCT, or consolidation/maintenance treatment. Because Ph-positive ALL is associated with a very poor prognosis, patients with this subtype were assigned to undergo allogeneic HCT (including matched, unrelated donor [URD] HCT), when possible. The 5-year OS rate among patients with Ph-positive and Ph-negative disease was 25% and 41%, respectively.⁸² Among patients with Ph-negative ALL, those older than 35 years or with elevated WBC count (>30 × 10⁹/L for B-cell lineage; >100 × 10⁹/L for T-cell lineage) at diagnosis were initially identified as high risk, whereas all others were classified as standard risk. The 5-year OS rates for the Ph-negative high-risk and standard-risk subgroups were 29% and 54%, respectively.⁸² Further analysis of the Ph-negative population according to risk factors showed that patients could be categorized as low risk (no risk factors based on age or WBC count),

intermediate risk (either age >35 years or elevated WBC count), or high risk (both age >35 years and elevated WBC count). The 5-year OS rates based on these risk categories were 55%, 34%, and 5%, respectively, suggesting that patients with Ph-negative ALL in the high-risk subgroup had even poorer survival outcomes than patients in the overall Ph-positive subgroup.⁸²

In a subsequent analysis from this MRC UKALL XII/ECOG E2993 study, cytogenetic data were evaluated in approximately 1000 patients.⁸³ The analysis confirmed the negative prognostic impact of Ph-positive status compared with Ph-negative disease, with a significantly decreased 5-year EFS rate (16% vs. 36%; $P < .001$, adjusted for age, gender, and WBC count) and OS rate (22% vs. 41%; $P < .001$, adjusted for age, gender, and WBC count). Among patients with Ph-negative disease, the following cytogenetic subgroups had significantly decreased 5-year EFS (13%–24%) and OS rates (13%–28%) based on univariate analysis: t(4;11) *MLL* translocation, t(8;14), complex karyotype (≥ 5 chromosomal abnormalities), and low hypodiploidy (30–39 chromosomes)/near triploidy (60–78 chromosomes).⁸³ In contrast, del(9p) or high hyperdiploidy (51–65 chromosomes) was associated with more favorable 5-year EFS (49%–50%) and OS rates (53%–58%).⁸³ An earlier report of data from patients treated on the French ALL study group (LALA) protocols suggested that near triploidy (60–78 chromosomes) may be derived from duplication of hypodiploidy (30–39 chromosomes); both aneuploidies were associated with poor DFS and OS outcomes similar to that of patients with Ph-positive ALL.⁸⁴ Based on multivariate Cox regression analysis reported in the MRC UKALL XII/ECOG E2993 study, t(8;14), low hypodiploidy/near triploidy, and complex karyotype remained significant independent predictors for risk of relapse or death; the prognostic impact of these cytogenetic markers was independent of factors such as age, WBC count, or T-cell

immunophenotype, and their significance was retained even after excluding patients who had undergone postinduction HCT.⁸³

The importance of cytogenetics as a prognostic factor for survival outcomes was shown in other studies, including the Southwest Oncology Group (SWOG) study conducted with 200 adult patients with ALL.⁸⁵ In this study, the prognostic impact of the different cytogenetic categories outweighed that of the more traditional factors, such as age and WBC count; in multivariate analysis for both relapse-free survival (RFS) and OS, cytogenetics remained a significant independent predictor of outcomes, whereas factors such as age and WBC count lost prognostic significance.⁸⁵ Moreover, the subgroup ($n = 19$) of patients with “very high risk” cytogenetic features (identified based on outcomes from the MRC/ECOG study mentioned earlier: presence of t(4;11) *MLL* translocation; t(8;14); complex karyotype; or low hypodiploidy) had substantially decreased 5-year RFS and OS rates (22%, for both endpoints). Analysis by ploidy status was not possible because only 2 patients were considered to have low hypodiploidy/near triploidy. The 5-year RFS and OS rates among patients with Ph-positive ALL ($n = 36$) were 0% and 8%, respectively.⁸⁵

NCCN Recommendations for Risk Assessment in ALL

Although some debate remains regarding the risk stratification approach to ALL, the panel suggests the following approaches for defining risk in these patients.

The NCI defines the age range for AYA patients as 15 to 39 years. This definition has been adopted for the AYA sections of the NCCN Guidelines for ALL. Because AYA patients may benefit from pediatric-inspired ALL treatment protocols, this patient population is considered separately from the adult population (defined as age ≥ 40 years). Given the poor prognosis associated with Ph-positive ALL and the wide

availability of agents that specifically target the BCR-ABL kinase, initial risk stratification for all patients (AYA or adult) is based on the presence or absence of the t(9;22) chromosomal translocation and/or BCR-ABL fusion protein. For adult patients with ALL (Ph-positive or Ph-negative), these guidelines further stratify patients by age, using 65 years as the cutoff, to guide treatment decisions. However, chronologic age alone is a poor surrogate for determining patient fitness for therapy. Patients should, therefore, be evaluated on an individual basis.

AYA patients and adult patients younger than 65 years of age (or for those with no substantial comorbidities) with Ph-negative ALL can be further categorized as having high-risk disease, which may be particularly helpful when consolidation with allogeneic HCT is being considered. Patients may be considered high risk if they have positive MRD, an elevated WBC count ($\geq 30 \times 10^9/L$ for B-cell lineage; $\geq 100 \times 10^9/L$ for T-cell lineage), or presence of poor-risk cytogenetics as previously defined. The absence of all poor-risk factors is considered standard risk. Evaluation of WBC count and age for determination of prognosis should ideally be made in the context of treatment protocol-based risk stratification. These additional risk stratification parameters are generally not used for patients aged 65 years or older (or for patients with substantial comorbid conditions) with Ph-negative ALL. Similar to AYA patients, elevated WBC count ($\geq 30 \times 10^9/L$ for B-cell lineage; $\geq 100 \times 10^9/L$ for T-cell lineage) has been considered a high-risk factor based on some earlier studies. However, more recent studies in adult patients have demonstrated that WBC counts may lose independent prognostic significance when cytogenetic factors are considered. Data showing the effect of WBC counts on prognosis in adult patients with ALL are less firmly established than in the pediatric population. Therefore, adult patients with ALL may not necessarily be classified as high risk based on high WBC count alone.

Overview of Treatment Phases in ALL Management

The treatment approach to ALL represents one of the most complex and intensive programs in cancer therapy. Although the specific treatment regimens and selection of drugs, dose schedules, and treatment durations differ between AYA patients and adults, and among different subtypes of ALL, the basic treatment principles are similar. The most common treatment regimens used in patients with ALL include modifications or variations of multiagent chemotherapy regimens originally developed by the Berlin-Frankfurt-Münster Group (BFM) for pediatric patients (eg, regimens used by COG for children and AYA patients, or the CALGB regimen for adult patients), and the hyper-CVAD regimen developed at MD Anderson Cancer Center (MDACC). In general, the treatment phases can be largely grouped into induction, consolidation, and maintenance. All treatment regimens for ALL include CNS prophylaxis and/or treatment.

Induction

The intent of initial induction therapy is to reduce tumor burden by clearing as many leukemic cells as possible from the bone marrow. Induction regimens are typically based on a backbone that includes a combination of vincristine, anthracyclines (eg, daunorubicin, doxorubicin), and corticosteroids (eg, prednisone, dexamethasone) with or without L-asparaginase and/or cyclophosphamide.^{1,22,28,31,38} In addition, antimetabolites, such as methotrexate, cytarabine, and/or 6-mercaptopurine (6-MP), are often included at induction therapy, primarily for CNS prophylaxis (see *CNS Prophylaxis and Treatment*).

The BFM/COG regimens are mainly based on a 4-drug induction regimen that includes a combination of vincristine, an anthracycline, a corticosteroid, and L-asparaginase.⁸⁶⁻⁹⁰ The CALGB regimens are typically based on a 5-drug regimen, which adds cyclophosphamide to

the above 4-drug combination.⁹¹ Randomized studies comparing the use of dexamethasone versus prednisone as part of induction therapy in children with ALL showed that dexamethasone significantly decreased the risk of isolated CNS relapse and improved EFS outcomes compared with prednisone.^{92,93} The observed advantage in outcomes with dexamethasone may partly be attributed to improved penetration of dexamethasone into the CNS.⁹⁴ In a meta-analysis comparing outcomes with dexamethasone versus prednisone in induction regimens for childhood ALL, dexamethasone was associated with a significantly reduced event rate (ie, death from any cause, refractory or relapsed leukemia, or second malignancy; risk ratio [RR], 0.80; 95% CI, 0.68–0.94) and CNS relapse (RR, 0.53; 95% CI, 0.44–0.65).⁹⁵ However, no advantage was seen with dexamethasone regarding risk for bone marrow relapse (RR, 0.90; 95% CI, 0.69–1.18) or overall mortality (RR, 0.91; 95% CI, 0.76–1.09), and dexamethasone was associated with a significantly higher risk of mortality during induction therapy (RR, 2.31; 95% CI, 1.46–3.66), neuropsychiatric adverse events (RR, 4.55; 95% CI, 2.45–8.46), and myopathy (RR, 7.05; 95% CI, 3.00–16.58) compared with prednisone.⁹⁵ Although dexamethasone was reported to reduce the risks for CNS relapse and improved EFS, toxicities may be of concern, and an advantage for OS has yet to be conclusively shown.

The hyper-CVAD regimen may be considered a less complex treatment regimen compared with CALGB regimen, and comprises 8 alternating treatment cycles with the “A” regimen (hyper-CVAD: hyperfractionated cyclophosphamide, vincristine, doxorubicin, and dexamethasone) and the “B” regimen (high-dose methotrexate and cytarabine).⁹⁶⁻⁹⁸ CNS prophylaxis and/or CNS-directed treatment (which may include cranial irradiation for patients with CNS leukemia at diagnosis), and

maintenance treatment are also used with the hyper-CVAD regimen (see *CNS Prophylaxis and Treatment and Maintenance*).

CNS Prophylaxis and Treatment

The goal of CNS prophylaxis and/or treatment is to prevent CNS disease or relapse by clearing leukemic cells within sites that cannot be readily accessed with systemic chemotherapy because of the blood-brain barrier. CNS-directed therapy may include cranial irradiation, intrathecal chemotherapy (eg, methotrexate, cytarabine, corticosteroids), and/or high-dose systemic chemotherapy (eg, methotrexate, cytarabine, 6-MP, L-asparaginase).^{1,38,94} CNS prophylaxis is typically given to all patients throughout the entire course of ALL therapy, from induction, to consolidation, to the maintenance phases of treatment.

Consolidation

The intent of postinduction consolidation is to eliminate any leukemic cells potentially remaining after induction therapy, further eradicating residual disease. The postremission induction phase of treatment (but before long-term maintenance therapy) may also be described as *intensification therapy*. The combination of drugs and duration of therapy for consolidation regimens vary largely among studies and patient populations but can comprise combinations of drugs similar to those used during the induction phase. High-dose methotrexate, cytarabine, 6-MP, and L-asparaginase are frequently incorporated into consolidation/intensification regimens, particularly for regimens geared toward children with ALL.^{24,28,31,38,89,90}

Maintenance

The goal of extended maintenance therapy is to prevent disease relapse after postremission induction and consolidation therapy. Most

maintenance regimens are based on a backbone of daily 6-MP and weekly methotrexate (typically with the addition of periodic vincristine and corticosteroids) for 2 years in adults and 2 to 3 years in children.^{22,28,31,38} Maintenance therapy is omitted for patients with mature B-cell ALL (see the NCCN Guidelines for Non-Hodgkin's Lymphoma: Burkitt Lymphoma), given that long-term remissions are seen early with short courses of intensive therapy in these patients, with relapses rarely occurring beyond 12 months.^{28,99}

Factors that affect the bioavailability of 6-MP can significantly impact patient care. Oral 6-MP can have highly variable drug and metabolite concentrations among patients.^{100,101} Furthermore, age, gender, and genetic polymorphisms can affect bioavailability.¹⁰²⁻¹⁰⁴ The concomitant use of other chemotherapeutic agents such as methotrexate can alter toxicity.¹⁰⁵ The efficacy of maintenance therapy is determined by the metabolism of 6-MP to the antimetabolite chemotherapeutic agent 6-thioguanine (6-TGN); however, other pathways compete for 6-MP, thereby reducing the amount of active metabolite produced. The three enzymes that metabolize 6-MP are xanthine oxidase (XO), hypoxanthine phosphoribosyltransferase (HPRT), and thiopurine methyltransferase (TPMT). Because 6-MP is administered orally, it can be converted to an inactive metabolite in the intestinal mucosa and liver.^{106,107} Diet has been shown to affect absorption of 6-MP.^{108,109} 6-MP can undergo thiol methylation by TPMT. The balance between metabolism by HPRT is inversely related to the activity of TPMT as demonstrated by the ability of TPMT polymorphism to affect metabolite production.¹¹⁰ Compared to the wild-type TPMT phenotype, patients who are homozygous TPMT-deficient require a 10- to 15-fold reduction in 6-MP to alleviate hematopoietic toxicity.^{111,112} Heterozygosity at the TPMT gene locus occurs in 5% to 10% of the population and has been shown to have intermediate enzyme activity.^{110,113,114} Therefore, a 10%

to 15% reduction in 6-MP dose is necessary in these patients to prevent toxicity.^{115,116} Determination of patient TPMT genotype using genomic DNA is recommended to optimize 6-MP dosing, especially in patients who experience myelosuppression at standard doses.^{117,118}

Dose reductions may be necessary if patients have genetic polymorphisms and/or hepatotoxicity, whereas dose escalation may be necessary in patients who demonstrate myelosuppression. This should be performed in accordance with the protocol being used. In general, protocols (including the ECOG/CALGB study) recommend a dose increase by 25% if an ANC greater than 1500 is observed for more than 6 weeks. The FDA recently approved an oral suspension of 6-MP, which may be more amenable to dose adjustments than the tablet form.¹¹⁹ This may be especially beneficial for dose adjustment in pediatric patients.¹²⁰ Outcomes are better in patients who achieve myelosuppression during maintenance compared with patients who have higher neutrophil counts,^{78,121} emphasizing the need for optimal dosing of 6-MP.

Noncompliance also results in undertreatment, particularly in the AYA population. Compliance issues should be addressed for patients without cytopenia. If increasing doses of 6-MP are given during maintenance but no drop in the counts is observed, this may be indicative of noncompliance.¹⁰⁵ Quantification of 6-MP metabolites can be very useful in determining whether the lack of myelosuppression is due to non-compliance or hypermetabolism.

Targeted Agents

The emergence of targeted therapies for hematologic malignancies, including the treatment of Ph-positive disorders with TKIs, represents an important advancement in ALL therapy. Imatinib mesylate is an inhibitor of BCR-ABL tyrosine kinase and is approved by the FDA for the

treatment of adult patients with relapsed or refractory Ph-positive ALL, and the treatment of previously untreated pediatric patients with Ph-positive ALL. Phase II studies in adults with ALL have shown imatinib to be efficacious as single-agent therapy in the relapsed/refractory¹²² and frontline settings,^{123,124} and in combination with chemotherapy regimens during initial induction, consolidation, and/or maintenance.¹²⁵⁻¹³¹

Dasatinib is a second-generation TKI that inhibits both the BCR-ABL kinase and SRC family kinase, the latter of which is thought to be involved in an alternative signaling pathway in imatinib-resistant ALL. Moreover, dasatinib displayed a 325-fold increased potency in inhibiting in vitro growth of cells with wild-type *BCR-ABL* compared with imatinib,¹³² and maintained activity against cells harboring imatinib-resistant *ABL* kinase domain mutations, with the exception of the T315I, V299L, and F317L mutations.¹³²⁻¹³⁴ In phase II and III dose-comparison studies, dasatinib showed activity in patients with relapsed or refractory ALL who could not tolerate or had disease that was resistant to imatinib.¹³⁴⁻¹³⁶ Additionally, dasatinib showed activity against CNS leukemia in preclinical in vivo models and in a small group of patients with Ph-positive ALL with CNS involvement.¹³⁷ Thus, it seems that dasatinib may provide some benefit over imatinib in terms of increased potency in inhibiting signaling pathways, activity against various *ABL* kinase mutations, and greater penetration of the blood-brain barrier.

Single-agent TKI therapy in Ph-positive ALL has demonstrated improved response to induction over chemotherapy, but both imatinib¹²⁴ and dasatinib¹³⁵ had a short duration with no remission. TKIs have shown the most benefit when given in concert with corticosteroids. Not only are DFS and OS rates significantly improved, but there is a reduction in adverse events¹³⁸ making this a possible treatment option for older or less fit patients with Ph-positive ALL (see *Initial Treatment in Adult Patients with Ph-Positive ALL*). Incorporation of TKIs into

treatment regimens should include evaluation of clinical pharmacokinetics.¹³⁹ Clinicians should be aware of variation among the TKIs relating to absorption from the gastrointestinal tract. Additionally, histamine-2 antagonist or proton pump inhibitors can affect the bioavailability of some TKIs.

In addition to imatinib and dasatinib, targeted agents include an anti-CD20 monoclonal antibody (eg, rituximab) for CD20-expressing B-cell lineage ALL (especially for mature B-cell ALL).^{140,141} In addition, the purine nucleoside analog nelarabine has been approved for the treatment of relapsed/refractory T-cell lineage ALL or lymphoblastic lymphoma.¹⁴²⁻¹⁴⁴ These agents may be incorporated as part of frontline induction, consolidation, and/or maintenance regimens during the course of initial ALL therapy, and in the relapsed or refractory disease settings.

Management of Ph-Positive ALL

Initial Treatment in AYA Patients with Ph-Positive ALL

Ph-positive ALL is rare in children with ALL, occurring in only approximately 3% of pediatric cases compared with 25% of adult cases.²⁹ The frequency of Ph-positive ALL is slightly higher (5%–7% of cases) among AYA patients,⁹⁰ although this subtype is still uncommon relative to its incidence in older adults. Historically, children and adolescents with Ph-positive disease had a poorer prognosis compared with patients with Ph-negative B-cell ALL. However, recent improvements in the treatment options are closing this gap.

Hematopoietic Cell Transplant

In a retrospective analysis of children with Ph-positive ALL treated between 1986 and 1996 (n = 326) with intensive chemotherapy regimens with or without allogeneic HCT, the 5-year EFS (calculated

from time of diagnosis) and OS rates were 28% and 40%, respectively, for the entire patient cohort.⁴² The 7-year EFS and OS rates were 25% and 36%, respectively. Even among the subgroup of patients considered to have a better prognosis (ie, WBC count $<50 \times 10^9/L$ and age <10 years), the 5-year DFS rate (calculated from time of first CR) was only 49%.⁴² Compared with patients who received only chemotherapy, the subgroup of patients who underwent allogeneic HCT with an HLA-matched related donor (n = 38) had significantly higher 5-year DFS (65% vs. 25%; $P < .001$) and OS (72% vs. 42%; $P = .002$) rates. This benefit with HCT versus chemotherapy alone was not observed with autologous HCT or with HCT from matched URDs. This study showed that allogeneic HCT from a matched related donor offered improvements in outcomes over chemotherapy alone.

In a subsequent analysis of outcomes in children with Ph-positive ALL treated between 1995 and 2005 but also without targeted TKIs, the 7-year EFS and OS rates were 32% and 45%, respectively.¹⁴⁵ Outcomes with allogeneic HCT from either matched related donors or URDs appeared similar, and HCT improved disease control over intensive chemotherapy alone.¹⁴⁵ Although this analysis showed an improved 7-year EFS rate, outcomes remained suboptimal in patients with Ph-positive ALL.

Allogeneic HCT has been considered the standard of care for AYA patients with Ph-positive ALL; however, its role has become less clear with the advent of BCR-ABL–targeted TKIs. Several studies evaluated the role of allogeneic HCT in the era of imatinib and whether imatinib-based therapies provided an additional benefit to HCT.

COG AALL-0031 Regimen

In a multicenter COG study (AALL-0031) of children and adolescents with high-risk ALL, the group of patients with Ph-positive ALL (n = 92;

age 1–21 years) was treated with an intensive chemotherapy regimen combined with imatinib (340 mg/m²/d; given during postremission induction therapy and maintenance).¹⁴⁶ Among the cohort (n = 44) who received continuous imatinib exposure (280 consecutive days before maintenance initiation), the 3-year EFS rate was 80.5% (95% CI, 64.5%–89.8%). This outcome compared favorably with that of a historical population of patients with Ph-positive ALL (n = 120) treated on a POG protocol, which showed a 3-year EFS rate of only 35% ($P < .0001$).¹⁴⁶ Moreover, the 3-year EFS rates were similar among the groups of patients who received chemotherapy combined with continuous imatinib (88%; n = 25) or allogeneic HCT from a related donor (57%; n = 21) or URD (72%; n = 11). No major toxicities were found to be associated with the addition of imatinib to the intensive chemotherapy regimen.¹⁴⁶

EsPhALL

The European intergroup study of post-induction treatment of Philadelphia-chromosome positive ALL (EsPhALL) reported results of the randomized open-label trial designed to evaluate the safety and long-term efficacy of discontinuous postinduction imatinib plus chemotherapy with the BFM backbone intensive treatment versus chemotherapy alone.¹⁴⁷ The study enrolled 108 good-risk and 70 poor-risk patients aged 1 year to 18 years. Good-risk patients were randomized 1:1 and poor-risk patients were all assigned to receive chemotherapy plus imatinib. There was a trend towards improved 4-year DFS for good-risk patients who received imatinib plus chemotherapy versus those who received chemotherapy alone (72.9% vs. 61.7%; $P = .24$). In the as-treated analysis, good-risk patients who received imatinib with chemotherapy had a 4-year EFS of 75.2% versus 55.9% in patients who did not receive imatinib ($P = .06$). The incidence of serious adverse events was not statically different between the two groups ($P = .64$).¹⁴⁷ Enrollment in this trail was stopped in 2009

following results of the COG AALL0031 study that demonstrated a benefit of continuous imatinib. The EsPhALL study has been amended to use continuous imatinib, though data are not yet available for this trial. Additionally, there is an ongoing AALL1122/BMS CA 180-372 trial that is evaluating continuous dasatinib plus the intensive BFM regimen.

TKIs Combined with Hyper-CVAD

A phase II study at MDACC evaluated imatinib combined with the hyper-CVAD regimen in patients with previously untreated or minimally treated ALL (n = 54; median age, 51 years; range, 17–84 years); 14 patients underwent subsequent allogeneic HCT.¹³¹ The 3-year OS rate with this regimen was 54%. Among the patients aged 40 years or younger (n = 16), a strong trend was observed for OS benefit with allogeneic HCT (3-year OS rate, 90% vs. 33%; $P = .05$).¹³¹ Among patients aged 60 years or younger, no statistically significant difference was observed in the 3-year OS rate between patients who received HCT and those who did not (77% vs. 57%).

Studies have shown the promising activity of dasatinib when incorporated into frontline regimens for patients with ALL. In a phase II study from MDACC, dasatinib was combined with hyper-CVAD and subsequent maintenance therapy in patients with previously untreated Ph-positive ALL (n = 35; median age, 53 years; range, 21–79 years; 31% were older than 60 years); 4 of the patients received allogeneic HCT at first CR.¹⁴⁸ The 2-year OS and EFS rates were 64% and 57%, respectively.

TKIs Combined with Multiagent Chemotherapy

In the phase II study from GRAALL (GRAAPH-2003), patients with previously untreated Ph-positive ALL (n = 45; median age, 45 years; range, 16–59 years) received imatinib in combination with chemotherapy during either induction or consolidation therapy.^{129,130}

Patients in complete remission with a donor received allogeneic HCT (n = 24), whereas those in complete remission with good molecular response but without a donor were eligible for autologous HCT (n = 10). Nine patients did not receive HCT and were treated with imatinib-based maintenance therapy. The 4-year OS rate did not differ significantly for patients with a sibling donor compared to patients undergoing autologous HCT (76% vs. 80%); however, patients receiving an allogeneic HCT from a URD had the lowest 4-year OS (11%). The 4-year OS for patients who received only maintenance imatinib was 33%.¹³⁰ These data suggest that improved survival with imatinib-based therapy can be further enhanced by the addition of HCT.

In the subgroup of patients with Ph-positive ALL (n = 94; median age, 47 years; range, 19–66 years) from the Northern Italy Leukemia Group study (NILG-09/00), outcomes were compared among patients who received chemotherapy with imatinib (n = 59) or without imatinib (n = 35), with or without subsequent HCT (allogeneic or autologous).¹⁴⁹ The patients who received imatinib (63% of eligible patients underwent allogeneic HCT) had significantly higher 5-year OS (38% vs. 23%; $P = .009$) and DFS rates (39% vs. 25%; $P = .005$) compared with those who did not receive imatinib (39% of eligible patients underwent allogeneic HCT).¹⁴⁹ The 5-year OS rates by treatment type were 47% for allogeneic HCT (n = 45), 67% for autologous HCT (n = 9), 30% for imatinib without HCT (n = 15), and 8% for no imatinib and no HCT (n = 13); the corresponding treatment-related mortality rates were 17%, 0%, 36%, and 23%, respectively. The 5-year relapse rates were 43%, 33%, 87%, and 100%, respectively.¹⁴⁹

In a phase II study from the Spanish Cooperative Group, patients with Ph-positive ALL (n = 30; median age, 42 years; range, 8–62 years; only 1 patient was <15 years of age) were treated with intensive chemotherapy combined with imatinib, followed by HCT and imatinib

maintenance.¹⁵⁰ Overall, 53% of patients proceeded to allogeneic HCT and 17% received autologous HCT. At a median follow-up of 4.1 years, the OS and DFS rates were both 30%. The incidence of transplant-related mortality was 27%.¹⁵⁰ Post-transplant maintenance with imatinib was not feasible in most patients, primarily because of transplant-related complications.

The Japan Adult Leukemia Study Group (ALL-202) treated patients with Ph-positive ALL (n = 100) with chemotherapy combined with imatinib administered during induction, consolidation, and maintenance phases.^{128,151} An early analysis (n = 80; median age, 48 years; range, 15–63 years) reported a 1-year OS rate of 73% among patients who underwent allogeneic HCT, compared with 85% for those who did not.¹²⁸ A subsequent analysis compared outcomes for the subgroup of patients who received allogeneic HCT at first CR in this study (n = 51; median age, 38 years; range, 15–64 years) versus those for a historical cohort of patients who received allogeneic HCT without prior imatinib (n = 122).¹⁵¹ The 3-year OS (65% vs. 44%; *P* = .015) and DFS rates (58% vs. 37%; *P* = .039) were significantly higher among patients treated with imatinib compared with the historical cohort; the 3-year non-relapse mortality rate was similar between cohorts (21% vs. 28%, respectively).¹⁵¹

Initial Treatment in Adults with Ph-Positive ALL

Historically, treatment outcomes for adult patients with Ph-positive ALL have been extremely poor. Before the era of targeted TKIs, the 3-year OS rates with chemotherapy regimens were generally less than 20%.¹²⁵ Allogeneic HCT, in the pre-imatinib era, resulted in some improvements over chemotherapy alone, with 2-year OS rates of 40% to 50%^{152,153} and 3-year OS rates of 36% to 44%.^{66,151} In the large, international, collaborative MRC UKALL XII/ECOG E2993 trial conducted in patients

with previously untreated ALL, the subgroup with Ph-positive disease (n = 267; median age, 40 years; range, 15–60 years) was eligible for allogeneic HCT if its patients were younger than 50 (in the ECOG E2993 trial) or 55 (in the MRC UKALL XII trial) years of age and had a matched sibling or matched URD.¹⁵⁴ Among the Ph-positive patient cohort, postremission treatment included matched sibling allogeneic HCT (n = 45), matched URD allogeneic HCT (n = 31), and chemotherapy alone (n = 86). The 5-year OS rate according to postremission therapy was 44%, 36%, and 19%, respectively, and the 5-year EFS rate was 41%, 36%, and 9%, respectively.¹⁵⁴ Both the OS and EFS outcomes for patients who underwent allogeneic HCT (related or unrelated) were significantly improved compared with those who received only chemotherapy. The incidence of transplant-related mortality was 27% with matched sibling allogeneic HCT and 39% with matched URD HCT. An intent-to-treat analysis of patients with a matched sibling donor versus those without a matched sibling donor showed no statistically significant difference in 5-year OS rates (34% vs. 25%, respectively).¹⁵⁴ The incorporation of imatinib in the treatment regimen for Ph-positive ALL has led to improvements in outcomes over chemotherapy alone.^{125,128,131}

TKIs Combined With Hyper-CVAD

Studies evaluating TKIs plus hyper-CVAD have included both AYA and adult patients.^{125,131,148,155} For discussion of these studies, refer to previous section (see *Initial Treatment in AYA Patients with Ph-positive ALL*).

TKIs Combined With Multiagent Chemotherapy

Studies evaluating TKIs plus multiagent chemotherapy have been discussed in the previous section (see *Initial Treatment in AYA Patients with Ph-positive AYA patients*). Numerous phase II studies have evaluated the efficacy of imatinib combined with chemotherapy

regimens in patients with previously untreated disease; these studies showed positive results with the combined regimen, particularly when treatment was followed by allogeneic HCT.^{125-131,149}

TKIs Combined With Corticosteroids

The treatment of older patients with Ph-positive ALL may pose a challenge, because elderly patients or those with comorbidities may not tolerate aggressive regimens with multiagent chemotherapy combined with TKIs. Several studies have evaluated outcomes with imatinib induction, with or without concurrent corticosteroids, in the older adult population with Ph-positive ALL. In a study that randomly assigned older patients with Ph-positive ALL (n = 55; median age, 68 years; range, 54–79 years; 94.5% were aged 60 years or older) to induction therapy with imatinib versus chemotherapy alone, followed by imatinib-containing consolidation therapy, the estimated 2-year OS rate was 42%; no significant difference was observed between induction treatment arms.¹²⁴ The median OS was numerically higher (but not statistically significant) among patients who received imatinib induction compared with those randomized to chemotherapy induction (23.5 vs. 12 months). However, the incidence of severe adverse events was significantly lower with imatinib induction (39% vs. 90%; $P = .005$), which suggested that induction therapy with imatinib may be better tolerated than chemotherapy in older patients with Ph-positive ALL.¹²⁴

In a study from GIMEMA (LAL-1205), patients with Ph-positive ALL (n = 53 evaluable; median age, 54 years; range, 24–76.5 years) received induction therapy with dasatinib and prednisone.¹³⁸ Postinduction therapy included no further therapy (n = 2), TKI only (n = 19), TKI combined with chemotherapy (n = 10) with or without autologous HCT (n = 4), or allogeneic HCT (n = 18). All patients experienced a CR after induction therapy. The median OS was 31 months and the median DFS (calculated from day +85) was 21.5 months. At 20 months, the OS and

DFS rates were 69% and 51%, respectively.¹³⁸ T315I mutation was detected in 12 of 17 patients with relapsed disease (71%).

In a small phase II study from GRAALL (AFR-09 study), older patients (age ≥55 years) with Ph-positive ALL (n = 29 evaluable; median age, 63 years) were treated with chemotherapy induction followed by a consolidation regimen with imatinib and methylprednisolone.¹⁵⁶ The 1-year OS rate in this study was significantly higher compared with the historical control population who received the same induction therapy but did not receive imatinib as part of consolidation (66% vs. 43%; $P = .005$), and the median OS in this study was longer than that of the control group (23 vs. 11 months, respectively). In addition, the 1-year RFS rate was significantly increased with the addition of imatinib (58% vs. 11%; $P < .001$).¹⁵⁶ A phase II study by GIMEMA (LAL0201-B study) also evaluated imatinib combined with corticosteroids in older patients (age >60 years) with Ph-positive ALL (n = 29 evaluable; median age, 69 years).¹⁵⁷ Patients received imatinib in combination with prednisone for induction. The estimated 1-year DFS and OS rates were 48% and 74%, respectively; the median OS was 20 months.¹⁵⁷

TKIs Combined with Vincristine and Dexamethasone

The phase II GRAALL study (GRAAPH-2005) compared induction therapy with high-dose imatinib (800 mg daily, days 1–28) combined with vincristine and dexamethasone (arm A) versus imatinib (800 mg daily, days 1–14) combined with hyper-CVAD (arm B) in patients younger than 60 years with previously untreated Ph-positive ALL.^{158,159} Eligible patients proceeded to HCT (allogeneic or autologous) after induction/consolidation phases. The primary endpoint was non-inferiority of the less intensive arm A regimen in terms of MRD response ($BCR-ABL / ABL$ ratio <0.1% by quantitative polymerase chain reaction [PCR]) after induction/consolidation. In an early report from this study (n = 118; n = 83 evaluable; median age 42 years), 52 patients proceeded

to HCT (allogeneic, n = 41; autologous, n = 11). The estimated 2-year OS rate was 62%, with no significant difference between patients who received imatinib with vincristine and dexamethasone and those who received imatinib with hyper-CVAD (68% vs. 54%, respectively).¹⁵⁸ The 2-year DFS rate was 43%, with no significant difference between induction arms (54% vs. 32%, respectively).

In an updated analysis from the GRAAPH-2005 study with a median follow-up of 40 months (N = 270; n = 265 evaluable; median age, 47 years), MRD response rates after induction/consolidation were similar between arm A and arm B (68% vs. 63.5%); MRD was undetectable in a similar proportion of patients (28% vs. 22%, respectively).¹⁵⁹ The less intensive regimen with high-dose imatinib combined with vincristine and dexamethasone was therefore considered non-inferior to imatinib combined with hyper-CVAD. No significant differences were observed between arm A and arm B in terms of estimated 3-year EFS (46% vs. 38%) or OS (53% vs. 49%) outcomes. Interestingly, among the patients who proceeded to HCT after MRD response, those who received autologous HCT showed a trend for improved 3-year RFS (63% vs. 49.5%) and OS (69% vs. 58%) compared with patients who received allogeneic HCT. This study suggested that outcomes with less intensive chemotherapy regimens (using high-dose imatinib) may offer similar benefits to more intensive imatinib-containing chemotherapy regimens.¹⁵⁹

In a European multicenter trial (EWALL-Ph-01 study), induction therapy with dasatinib combined with low-intensity chemotherapy (vincristine and dexamethasone) was evaluated in older patients (age ≥55 years) with Ph-positive ALL (n = 71; median age, 69 years; range, 58–83 years).¹⁶⁰ The CR rate after induction was 94%; MRD response (*BCR-ABL* / *ABL* ratio ≤0.1%) occurred in 54% of patients and 22% had undetectable MRD. The estimated 3-year RFS and OS were 43% and

45%, respectively.¹⁶⁰ Relapse occurred in 29 patients (41%) after a median of 9 months (range, 3–34 months); 24 patients died. The *ABL* mutation T315I was found in 63% of relapsed cases; mutations in F317L and V299L were found in 7% and 4% of relapsed cases, respectively.¹⁶⁰ These studies suggest that the use of TKIs, either alone or in combination with less intensive therapies (eg, corticosteroids with or without vincristine), may provide an alternative treatment option for older patients with Ph-positive ALL for whom intensive regimens are not appropriate.

TKIs in Maintenance Therapy

Collectively, the incorporation of imatinib into the therapeutic regimen has demonstrated improved outcomes for adult patients with Ph-positive ALL, particularly when administered before allogeneic HCT. Given that patients can experience relapse following allogeneic HCT, strategies are needed to prevent disease recurrence. One strategy involves the incorporation of post-HCT maintenance therapy with TKIs, which has been investigated in several studies. In a small prospective study in patients with Ph-positive leukemias who underwent allogeneic HCT (n = 15 with ALL; median age, 37 years; range, 4–49 years), imatinib was administered from the time of engraftment until 1 year after HCT.¹⁶¹ The median time after HCT until initiation of imatinib was short, at 27 days (range, 21–39 days). Molecular remission (by PCR) was observed in 46% of patients (6 of 13) prior to HCT and 80% (12 of 15) after HCT. Two patients died after hematologic relapse and 1 patient died due to acute respiratory distress syndrome approximately 1 year post-HCT. At a median follow-up of 1.3 years, 12 patients (80%) were alive without detectable disease.¹⁶¹ This was one of the first prospective studies to show the feasibility of administering imatinib maintenance early in the post-HCT period (<90 days) when the leukemic tumor burden tends to be low.

Maintenance therapy with imatinib was also evaluated in a prospective study in patients who underwent allogeneic HCT (n = 82; median age, 28.5 years; range, 3–51 years).¹⁶² Imatinib was scheduled for a period of 3 to 12 months (until three consecutive tests were negative for *BCR-ABL* transcripts or sustained molecular CR for at least 3 months). Among the patients who received imatinib (n = 62), the median time after HCT until initiation of imatinib was 70 days (range, 20–270 days). In this group of patients, 84% were alive with a molecular CR at a median follow-up of 31 months.¹⁶² Imatinib was discontinued in 16% of patients receiving treatment due to toxicities. The remaining patients (n = 20) who did not receive maintenance with imatinib (due to cytopenias, infections, graft-versus-host disease [GVHD], or patient choice) constituted the non-imatinib group. The estimated 5-year relapse rate was significantly lower with imatinib compared with no imatinib (10% vs. 33%; $P = .0016$) and the estimated 5-year DFS (81.5% vs. 33.5%; $P < .001$) and OS rates (87% vs. 34%; $P < .001$) were significantly longer with imatinib compared with no imatinib.¹⁶²

The previous study was not designed as a randomized controlled trial, and the number of patients in the non-imatinib group was small. A multicenter randomized trial evaluated imatinib given prophylactically (n = 26) compared with imatinib given at the time of MRD detection (ie, molecular recurrence; n = 29) in patients who underwent allogeneic HCT with a planned duration of imatinib therapy for 1 year.¹⁶³ MRD was defined by the appearance of *BCR-ABL* transcripts, as assessed by quantitative RT-PCR performed at a central laboratory. In the prophylactic arm, imatinib was started in 24 patients (92%) at a median time of 48 days (range, 23–88 days) after HCT. In the MRD-triggered arm, imatinib was started in 14 patients (48%) at a median time of 70 days (range, 39–567 days) after HCT. Imatinib was discontinued prematurely in the majority of patients in both arms (67% in the

prophylaxis arm; 71% in the MRD-triggered arm), primarily because of toxicities.¹⁶³ Ongoing CR was observed in 81% of patients in the prophylaxis arm (median follow-up, 30 months) and in 78% of patients in the MRD-triggered arm (median follow-up, 32 months). No significant differences were found between the prophylaxis and MRD-triggered arms in terms of relapse rate (8% vs. 17%), 5-year DFS (84% vs. 60%), EFS (72% vs. 54%), or OS (80% vs. 74.5%).¹⁶³ However, MRD positivity was predictive of relapse regardless of treatment arm; the 5-year RFS rate was significantly lower among patients with detectable MRD compared with those who remained MRD negative (70% vs. 100%; $P = .017$). Moreover, early MRD positivity (within 100 days after HCT) was associated with significantly decreased EFS compared with late MRD detection (median, 39 months vs. not reached [NR]; 4-year EFS, 39% vs. 65%; $P = .037$).¹⁶³ This trial suggested that imatinib given post-allogeneic HCT (either prophylactically or based on MRD detection) resulted in low relapse rates and durable remissions. However, imatinib may not provide benefit for patients who experience early molecular relapse or persistent MRD following HCT. Although no randomized controlled trials have yet been conducted to establish the efficacy of TKIs (compared with observation only or other interventions) following allogeneic HCT, the collective results from these studies suggest that TKI maintenance may have a potential role in reducing the risk for relapse.

Treatment of Relapsed Ph-Positive ALL

The treatment of patients who experience relapse after initial therapy for ALL remains a challenge, because these patients have a very poor prognosis. Several large studies have reported a median OS of only 4.5 months to 6 months, and a 5-year OS rate of 3% to 10% among patients who experience relapse after initial treatment.¹⁶⁴⁻¹⁶⁷ One major factor associated with poorer survival outcomes after subsequent

therapy for relapsed ALL is the duration of response to frontline treatment. In an analysis of data from the PETHEMA trials, patients with disease that relapsed more than 2 years after frontline therapy had significantly higher 5-year OS rates than the groups of patients who relapsed within 1 to 2 years or within 1 year of frontline therapy (31% vs. 15% vs. 2%; $P < .001$).¹⁶⁵ Similarly, in the MRC UKALL XII/ECOG E2993 trial, patients with disease that relapsed more than 2 years after initial diagnosis and frontline therapy had a significantly higher 5-year OS rate than those who relapsed within 2 years (11% vs. 5%; $P < .001$).¹⁶⁴ In the pre-imatinib era, patients with Ph-positive ALL who relapsed after frontline therapy had dismal outcomes; subgroup data from the large, prospective trials LALA-94 and MRC UK XII/ECOG E2993 showed a median OS of 5 months and a 5-year OS rate of 3% to 6% among patients subsequently treated for relapsed Ph-positive ALL.^{164,166}

Tyrosine Kinase Inhibitors

CNS relapse has been reported in both patients with disease responsive to imatinib therapy (isolated CNS relapse with CR in marrow) and patients with disease resistant to imatinib therapy.¹⁶⁸⁻¹⁷¹ The concentration of imatinib in the cerebrospinal fluid (CSF) has been shown to be approximately 2 logs lower than that achieved in the blood, suggesting that this agent does not adequately penetrate the blood-brain barrier to ensure CNS coverage.^{169,171} A study showed that among patients with ALL treated with imatinib and who did not receive routine prophylactic intrathecal therapy or cranial irradiation, 12% developed CNS leukemia.¹⁷⁰ Patients with imatinib-resistant disease who developed CNS disease rapidly died from progressive disease (PD); conversely, patients with imatinib-sensitive disease who developed isolated CNS relapse could be successfully treated with intrathecal therapy with or without cranial irradiation.^{168,170}

The emergence of resistance to TKI therapy poses a challenge for patients with disease that is primary refractory to or that relapses after initial treatment with TKI-containing regimens. Point mutations within the *ABL* kinase domain and alternative signaling pathways mediated by the SRC family kinase have been implicated as mechanisms of resistance to imatinib.^{133,172-176} Mutations within the *ABL* kinase domain have been identified in a large proportion of patients who experience disease recurrence after imatinib-containing therapy.^{173,175} Moreover, *ABL* kinase domain mutations may be present in a small group of imatinib-naïve patients even before initiation of any TKI therapy.^{177,178}

Dasatinib and nilotinib are second-generation TKIs that have shown greater potency in inhibiting *BCR-ABL* compared with imatinib, and retention of antileukemic activity in cells with certain imatinib-resistant *ABL* mutations.^{132-134,179,180} Both TKIs have been evaluated as single-agent therapy in patients with Ph-positive ALL that is resistant or intolerant to imatinib treatment.^{135,136,181,182} A randomized phase III study examined the activity of dasatinib administered as once-daily (140 mg daily) versus twice-daily (70 mg twice daily) dosing in patients with Ph-positive leukemia resistant to imatinib;¹³⁶ the once-daily dosing resulted in a higher response rate (major cytogenetic response) than the twice-daily dosing (70% vs. 52%). Although the median OS was shorter with the once-daily dosing (6.5 vs. 9 months), the median PFS was longer (4 vs. 3 months).¹³⁶ These differences in outcomes between the dosing arms were not statistically significant.

Dasatinib in combination with hyper-CVAD was investigated in a phase II trial ($n = 34$) that included patients with Ph-positive relapsed ALL ($n = 19$) and patients with lymphoid blast phase chronic myelogenous leukemia (CML) ($n = 15$).¹⁸³ An overall response rate of 91% was obtained with 26 patients achieving cytogenetic CR, 13 patients having molecular CR, and 11 patients having a major molecular response.

There were 9 patients who went on to receive allogeneic HCT, including 2 patients with ALL. In the patients with relapsed ALL, 30% remained in CR at 3 years (median, 8.8 months) with a 3-year OS of 26% (median, 9 months). At the median follow-up of 52 months (range, 45–59 months), 2 patients with ALL were still alive (11%).

Not all imatinib-resistant *ABL* mutations are susceptible to the newer TKIs. For instance, dasatinib is not as active against cells harboring the *ABL* mutations T315I, V299L, and F317L.^{132-134,176,184-186} Thus, for patients with disease resistant to TKI therapy, it becomes important to identify potential *ABL* mutations that may underlie the observed resistance to treatment. A panel of experts from the European LeukemiaNet published recommendations for the analysis of *ABL* kinase domain mutations in patients with CML, and treatment options according to the presence of different *ABL* mutations.¹⁸⁷

Ponatinib is a TKI that was initially approved by the FDA in December 2012 for the treatment of adult patients with chronic, accelerated, or blast phase Ph-positive CML or Ph-positive ALL, with resistance or intolerance to prior therapy.¹⁸⁸ Though temporarily removed from the market in November 2013, ponatinib distribution resumed in December 2013 following revision to both the prescribing information and REMS program to address the risk for serious cardiovascular adverse events. This TKI has been shown to inhibit both native and mutant forms of BCR-ABL (including those resulting from T315I mutation) in preclinical studies.^{188,189}

In a phase I dose-escalation study that evaluated ponatinib in heavily pretreated patients with Ph-positive leukemias resistant to prior TKI agents, major hematologic response was reported in 36% of the subgroup of patients with accelerated or blast phase CML or Ph-positive ALL (n = 22).¹⁸⁹ Major cytogenetic response occurred in 7 patients

(32%), with a cytogenetic CR in 3 patients (14%). Response outcomes in the small group of patients with T315I mutation (n = 7) appeared similar to those in the overall subgroup.¹⁸⁹

In the multicenter, open-label, phase II study (PACE trial; n = 449 enrolled; median age, 59 years, range 18–94 years), ponatinib showed substantial activity in patients with Ph-positive leukemias resistant or intolerant to second-generation TKIs.¹⁹⁰ Patients in this trial were heavily pretreated, with 58% having previously received at least 3 TKIs. Among the subgroup of patients with Ph-positive ALL (n = 32), the median age was 62 years (range, 20–80 years) and 41% were age 65 years or older. Major hematologic response among the subgroup with Ph-positive ALL was 41%; major and complete cytogenetic response was 47% and 38%, respectively. The estimated PFS rate at 12 months was 7% (median, 3 months), and the OS rate at 12 months was estimated to be 40% (median, 8 months). In the subset of patients with Ph-positive ALL with *ABL* T315I mutation (n = 22), major hematologic response was 36%, and major and complete cytogenetic response was 41% and 32%, respectively.¹⁹⁰ No significant differences in duration or OS outcomes were apparent based on *ABL* T315I mutation status; however, the patient numbers were small.¹⁹⁰ The most common overall treatment-related adverse events in the PACE trial included thrombocytopenia (37%), rash (34%), dry skin (32%), abdominal pain (22%), neutropenia (19%), and anemia (13%); pancreatitis was the most common serious event, reported in 5% of patients.¹⁹⁰ These studies demonstrated the activity of ponatinib in patients with Ph-positive leukemias resistant to other TKIs, including those with Ph-positive ALL harboring a T315I mutation.

Bosutinib, a TKI that acts as a dual inhibitor of BCR-ABL and SRC family kinases,^{191,192} was approved in September 2012 by the FDA for the treatment of chronic, accelerated, or blast phase Ph-positive CML in

adult patients with resistance or intolerance to prior therapy. The FDA approval was based on an open-label, multicenter phase I/II trial in patients with chronic, accelerated or blast phase CML previously treated with at least one prior TKI therapy; all patients had received prior imatinib therapy.¹⁹² The efficacy and safety of this agent in patients with relapsed/refractory Ph-positive ALL have not been established.

Hematopoietic Cell Transplant

Treatment options are extremely limited for patients with Ph-positive ALL who experience relapse after receiving allogeneic HCT. Several published cases have reported on the feasibility of inducing a molecular CR with dasatinib in patients with Ph-positive ALL who have experienced an early relapse after first allogeneic HCT.^{193,194} The patients subsequently received a second allogeneic HCT. Studies entailing donor lymphocyte infusion (DLI) to induce further graft-versus-leukemia effect in patients with Ph-positive ALL experiencing disease relapse after allogeneic HCT have reported little to no benefit, though it has been suggested that this is due to a leukemic burden that may have been too high to effectively control.^{195,196} Indeed, published case reports have suggested that the use of DLI for residual disease or molecular relapse (as noted by levels of *BCR-ABL* fusion mRNA measured with PCR) after allogeneic HCT may eliminate residual leukemic clones and thereby prevent overt hematologic relapse.¹⁹⁷⁻¹⁹⁹ Moreover, case reports have suggested using newer TKIs, such as dasatinib and nilotinib, along with DLI to manage relapse after allogeneic HCT.^{200,201} A case report described the treatment course and outcome in a patient who experienced early hematologic relapse after allogeneic HCT (performed in first CR), responded to imatinib-based multiagent chemotherapy and DLI (with persistent residual disease based on *BCR-ABL* transcripts), but then experienced a second hematologic relapse.²⁰² The disease progressed through second-line therapy with imatinib-based multiagent chemotherapy, and the patient received dasatinib, which resulted in a

hematologic CR; the patient subsequently underwent a second allogeneic HCT and maintained a molecular CR lasting 18 months.²⁰² Although these approaches are promising, only limited data based on case reports are available. Evidence from prospective studies is needed to establish the role of DLI, with or without TKIs, in the treatment of relapsed disease.

Blinatumomab

In December 2014, the FDA approved blinatumomab for the treatment of relapsed or refractory Ph-negative precursor B-cell ALL (see *Treatment of Relapsed Ph-Negative ALL*). Blinatumomab was shown to eliminate residual disease in 80% of patients with relapsed disease or MRD-positive B-precursor ALL after intensive chemotherapy (N = 21; n = 20 evaluable); five patients with Ph-positive B-cell precursor ALL were enrolled.²⁰³ Three patients had disease that responded within the first 2 cycles of treatment. While there were not enough patients for definitive analysis of this subgroup, data suggest that blinatumomab may also improve outcomes for relapsed or refractory Ph-positive precursor B-cell ALL. The Alcantara trial is currently investigating blinatumomab in a larger cohort of patients with Ph-positive B-cell ALL with relapsed disease or disease refractory to at least one second- or third-generation TKI (ie, dasatinib, nilotinib, bosutinib, ponatinib) or intolerant to second-generation TKI and intolerant or refractory to imatinib mesylate (clinicaltrials.gov; NCT02000427).

CAR T-cells

Chimeric antigen receptor (CAR) T-cells are a newer strategy for treating patients with relapsed or refractory ALL and has shown significantly greater OS than current regimens. Currently, bone marrow transplant is the only cure for relapsed/refractory ALL, but many patients are not eligible for transplant based on age or progression of the disease. The pre-treatment of patients with CAR T-cells has served

as a bridge for transplant, and patients who were formally unable to be transplanted due to poor remission status have a CR and ultimately transplantation. There are fewer side effects to this treatment compared to the current standard-of-care regimens; while side effects from CAR T-cells may be severe, they have been reversible. Adverse events are attributed to cytokine release syndrome and macrophage activation that occur in direct response to adoptive cell transplant resulting in high fever, hypotension, breathing difficulties, delirium, aphasia, and neurologic complications. Improvement in patient monitoring has shown successful treatment of these symptoms with the monoclonal antibody tocilizumab, an antagonist of interleukin-6.²⁰⁴ Based on their ability to elicit a significant response towards elimination of tumor cells, multicenter phase II studies are planned for CAR T-cells in the treatment of relapsed/refractory ALL. CAR T-cells can be used in the treatment of patients with Ph-positive or Ph-negative disease; however, the use of this regimen is restricted to clinical trials and data are not yet sufficient for incorporation into routine treatment of patients with ALL (see *Treatment of Relapsed Ph-Negative ALL*).

NCCN Recommendations for Ph-Positive ALL

AYA Patients (Age 15–39 Years) with Ph-Positive ALL

The panel recommends that AYA patients with Ph-positive ALL be treated in a clinical trial, when possible. In the absence of an appropriate clinical trial, the recommended induction therapy would comprise multiagent chemotherapy combined with a TKI. Treatment regimens should include adequate CNS prophylaxis for all patients. It is also important to adhere to the treatment regimens for a given protocol in its entirety, from induction therapy to consolidation/delayed intensification to maintenance therapy. For AYA patients experiencing a CR after initial induction therapy, consolidation with allogeneic HCT should be considered if a matched donor is available. However, in

younger AYA patients (age ≤ 21 years), emerging data suggest that allogeneic HCT may not confer an advantage over chemotherapy combined with TKIs.¹⁴⁶ Maintenance therapy (for 2–3 years) with a TKI, with or without monthly pulses of vincristine/prednisone, is recommended after HCT. Weekly methotrexate and daily 6-MP may be added to the maintenance regimen, as tolerated; however, the doses of these antimetabolite agents may need to be reduced in the setting of hepatotoxicity or myelosuppression. For patients without a donor, consolidation therapy after a CR should comprise a continuation of multiagent chemotherapy combined with a TKI. These patients should continue to receive post-consolidation maintenance therapy with a regimen that includes a TKI. Individuals who inherit a nonfunctional variant allele of the *TPMT* gene are known to be at high risk for developing hematopoietic toxicity (in particular, severe neutropenia) after treatment with 6-MP.¹¹⁶ Testing for the *TPMT* gene polymorphism should be considered in patients receiving 6-MP as part of maintenance therapy, particularly those who experience severe bone marrow toxicities (see *Role of MRD Monitoring*).

The treatment approach for AYA patients experiencing less than a CR after initial induction therapy (ie, having primary refractory disease) would be similar to that for patients with relapsed/refractory ALL (see *Patients with Relapsed/Refractory Ph-Positive ALL*).

Adult Patients (Age ≥ 40 Years) with Ph-Positive ALL

For adult patients with Ph-positive ALL, the panel recommends treatment in a clinical trial, when possible. In the absence of an appropriate clinical trial, the recommended induction therapy would initially depend on the patient's age and/or presence of comorbid conditions. Treatment regimens should include adequate CNS prophylaxis for all patients, and a given treatment protocol should be followed in its entirety. Although the age cutoff indicated in the

guidelines has been set at 65 years, it should be noted that chronologic age alone is not a sufficient surrogate for defining fitness; patients should be evaluated on an individual basis to determine fitness for therapy based on factors such as performance status, end-organ function, and end-organ reserve.

For relatively fit adult patients (age <65 years or with no substantial comorbidities), the recommended treatment approach is similar to that for AYA patients. Induction therapy would comprise multiagent chemotherapy combined with a TKI. For patients experiencing a CR after induction, consolidation with allogeneic HCT should be considered if a matched donor is available. After HCT, maintenance therapy (for 2–3 years) with a TKI, with or without monthly pulses of vincristine/prednisone for 2 to 3 years is recommended. Weekly methotrexate and daily 6-MP may be added to the maintenance regimen, as tolerated; however, the doses of these antimetabolite agents may need to be reduced in the setting of hepatotoxicity or myelosuppression. For patients without a donor, consolidation therapy after a CR should comprise a continuation of multiagent chemotherapy combined with a TKI. These patients should continue to receive post-consolidation maintenance therapy with a regimen that includes a TKI. Again, testing for *TPMT* gene polymorphism should be considered for patients receiving 6-MP as part of maintenance therapy, especially those who develop severe bone marrow toxicities after its initiation. For patients with less than a CR after induction, the treatment approach would be similar to that for patients with relapsed/refractory disease (see *Patients with Relapsed/Refractory Ph-Positive ALL*).

For adult patients who are less fit (age ≥65 years or with substantial comorbidities), the recommended induction therapy includes a TKI with corticosteroids or with chemotherapy regimens. Dose modifications may be required for chemotherapy agents, as needed. Patients with a CR to

induction should continue consolidation therapy with a TKI with or without corticosteroids or a TKI with or without chemotherapy; maintenance therapy (for 2–3 years) with a TKI, with or without monthly pulses of vincristine/prednisone for 2 to 3 years is recommended. Weekly methotrexate and daily 6-MP may be added to the maintenance regimen, as tolerated; however, the doses of antimetabolites may need to be reduced in the setting of hepatotoxicity or myelosuppression. Adult patients with less than a CR after induction should be managed similarly to those with relapsed/refractory disease (see *Patients with Relapsed/Refractory Ph-Positive ALL*).

Patients with Relapsed/Refractory Ph-Positive ALL

Mutation testing for the *ABL* gene should be considered in patients with Ph-positive ALL that has relapsed after or is refractory to initial TKI-containing therapy given that certain mutations may account for the observed resistance to induction therapy. The panel has largely adopted the recommendations for treatment options based on *ABL* mutation status for CML, as published by the European LeukemiaNet.¹⁸⁷ Based on these published recommendations and other studies, dasatinib (if not administered during initial induction) is a preferred option for patients with relapsed/refractory Ph-positive disease that has the mutations Y253H, E255K/V, or F359V/C/I.^{135,136} Ponatinib, also a preferred option, has activity against and is effective in treating the T315I mutation.¹⁹⁰ However, due to the high frequency of serious vascular events with ponatinib therapy, the FDA indication is restricted to the treatment of patients with the T315I mutation or in patients with disease resistant to other TKI therapies. Imatinib is also a preferred option for patients with relapsed/refractory disease.¹²² For patients with relapsed/refractory disease who have the mutations V299L, T315A, or F317L/V/I/C, nilotinib could be considered.

For patients with relapsed/refractory disease, participation in a clinical trial is preferred. In the absence of an appropriate trial, patients may be considered for second-line therapy with an alternative TKI (ie, different from the TKI used as part of induction therapy) alone, TKI combined with multiagent chemotherapy, TKI combined with corticosteroids (especially for elderly patients who may not tolerate multiagent combination therapy), or allogeneic HCT if a donor is available. For patients with disease that relapses after an initial allogeneic HCT, other options may include a second allogeneic HCT and/or DLI. For patients with Ph-positive ALL that is refractory to TKIs, regimens for relapsed/refractory Ph-negative ALL can be considered (*See Treatment of Relapsed Ph-Negative ALL*).

Management of Ph-Negative ALL

Initial Treatment in AYAs with Ph-Negative ALL

The AYA population with ALL can pose a unique challenge given that patients may be treated with either a pediatric (preferred) or an adult protocol, depending on local referral patterns and institutional practices. Retrospective analyses based on cooperative group studies from both the United States and Europe have consistently shown the superior outcomes for AYA patients (age 15–21 years) treated on pediatric versus adult ALL regimens. In the AYA population, 5-year EFS rates ranged from 63% to 74% for patients treated on a pediatric study protocol versus 34% to 49% for those receiving the adult protocol.^{63,64,90,205,206} In a recent retrospective comparative study that analyzed outcomes of AYA patients (age 16–20 years) treated on a pediatric CCG study protocol (n = 197; median age, 16 years) versus an adult CALGB study protocol (n = 124; median age, 19 years), patients treated on the pediatric regimen compared with those on the adult regimen had a significantly improved 7-year EFS (63% vs. 34%, respectively; $P < .001$) and OS (67% vs. 46%, respectively; $P < .001$)

rates.⁹⁰ Moreover, AYA patients treated on the adult protocol experienced a significantly higher rate of isolated CNS relapse at 7 years (11% vs. 1%; $P = .006$). The substantial improvements in outcomes observed with the pediatric regimen in this study, and in the earlier retrospective analyses from other cooperative groups, may be attributed largely to the use of greater cumulative doses of drugs, such as corticosteroids (prednisone and/or dexamethasone), vincristine, and L-asparaginase, and to earlier, more frequent, and/or more intensive CNS-directed therapy compared with adult regimens.⁹⁰ Given the success seen with multiagent intensive chemotherapy regimens for pediatric patients with ALL, several clinical trials have evaluated pediatric-inspired regimens for the AYA patient population.

CCG-1961

The CCG-1961 trial was a seminal study that allowed comparison of adult versus pediatric regimens in AYA patients. In an analysis of outcomes in children and AYA patients treated in the Dana-Farber Cancer Institute (DFCI) ALL Consortium Protocols (1991–2000), the 5-year EFS rate among younger AYA patients (age 15–18 years; n = 51) was 78%, which was not significantly different from the EFS rates observed for children aged 10 to 15 years (77%; n = 108) or those aged 1 to 10 years (85%; n = 685).²⁰⁷ The CCG 1961 study was designed to evaluate the benefit of augmented versus standard postinduction intensification therapy in children aged 1 to 9 years with high WBC counts ($\geq 50 \times 10^9/L$) or in older children and adolescents aged 10 to 21 years.⁸⁹ Patients were stratified by their initial response to induction therapy as either slow early responders (patients with $>25\%$ bone marrow blasts on day 7 of induction) or rapid early responders. Among the patients who were rapid early responders to induction (n = 1299), the augmented postinduction intensity arm was associated with significantly increased rates of 5-year EFS (81% vs. 72%; $P < .0001$) and OS (89% vs. 83%; $P = .003$) compared with the standard-intensity

arm.⁸⁹ In the subgroup of AYA patients (age 16–21 years; n = 262) from the CCG 1961 study treated with either augmented or standard-intensity regimens, the 5-year EFS and OS rates were 71.5% and 77.5%, respectively.²⁰⁸ Among the AYA patients who were considered rapid early responders, the augmented-intensity (n = 88) and standard-intensity (n = 76) arms showed no statistically significant differences in rates of 5-year EFS (82% vs. 67%, respectively) or OS (83% vs. 76%, respectively). For the AYA patients who were considered slow early responders (all of whom received the augmented-intensity regimen), the 5-year EFS rate was 71%.²⁰⁸

COG AALL0232

The AALL0232 trial enrolled 2154 patients between the ages of 1 and 30 years who were diagnosed with high-risk B-cell ALL.²⁰⁹ In this study patients were randomly assigned to receive dexamethasone versus prednisone during induction and high-dose methotrexate versus Capizzi escalating-dose methotrexate plus pegaspargase during interim maintenance 1. High-dose methotrexate showed improved 5-year EFS (80% vs. 75%; $P = .008$) and OS ($88.9\% \pm 1.2\%$ vs. $86.1\% \pm 1.4\%$; $P = 0.25$) rates compared to Capizzi escalating-dose methotrexate. No statistically significant difference was reported in the occurrence of mucositis, neurotoxicity, osteonecrosis, or other toxicities. The ALL0232 trial compared dexamethasone 10 mg/m²/d for 14 days to 60 mg/m²/d of prednisone for 28 days. Dexamethasone showed improved outcomes during induction patients in younger than 10 years of age; however, it was associated with a higher risk of osteonecrosis in patients 10 years of age or older. These data suggest that age may be an important factor for the selection of a corticosteroid.²⁰⁹

PETHEMA ALL-96 Regimen

In the PETHEMA ALL-96 trial, adolescent (n = 35; age 15–18 years) and young adult (n = 46; age 19–30 years) patients with standard-risk

Ph-negative ALL [defined as WBC count $<30 \times 10^9/L$; absence of t(9;22), t(1;19), t(4;11), or any other 11q23 rearrangements] received frontline therapy with a 5-drug induction regimen (vincristine, daunorubicin, prednisone, L-asparaginase, and cyclophosphamide), consolidation/reinduction, and maintenance, along with triple intrathecal therapy throughout the treatment period.²¹⁰ The 6-year EFS and OS rates for the entire patient cohort were 61% and 69%, respectively. No difference in EFS rate was observed between adolescents (60%; 95% CI, 43%–77%) and young adults (63%; 95% CI, 48%–78%); similarly, no significant difference was observed in OS for adolescents (77%; 95% CI, 63%–91%) versus young adults (63%; 95% CI, 46%–80%).²¹⁰ Based on multivariate regression analysis, slow response to induction therapy (defined as having $>10\%$ blast cells in the bone marrow aspirate performed on day 14 of treatment) was the only factor associated with a poor EFS (odds ratio [OR], 2.99; 95% CI, 1.25–7.17) and OS (OR, 3.26; 95% CI, 1.22–8.70).²¹⁰

DFCI ALL Regimen Based on DFCI Protocol 00-01

A multicenter phase II trial evaluated the pediatric-inspired regimen based on the DFCI Childhood ALL Consortium Protocol 00-01 in AYA and adult patients (age 16–50 years) with previously untreated ALL; 20% of the patients in this study had Ph-positive disease.²¹¹ The treatment regimen comprised induction (vincristine, doxorubicin, prednisone, L-asparaginase, and high-dose methotrexate), triple intrathecal therapy, intensification, and maintenance. Among the 75 patients with evaluable data, the estimated 2-year EFS and OS rates were 72.5% and 77%, respectively.²¹¹ Adverse events included 1 death from sepsis (during induction), pancreatitis in 9 patients (12%; including 1 death), osteonecrosis in 2 patients (3%), thrombosis/embolism in 14 patients (19%), and neutropenic infection in 23 patients (31%).²¹¹ Although this intensive regimen was feasible in adult patients, further follow-up data are needed to evaluate long-term survival outcomes.

GRAALL-2003 Regimen

The prospective phase II GRAALL-2003 study evaluated a pediatric-inspired regimen using intensified doses of vincristine, prednisone, and asparaginase for adolescents and adults with Ph-negative ALL (n = 225; median age, 31 years; range, 15–60 years).²¹² The induction regimen comprised vincristine, daunorubicin, prednisone, L-asparaginase, and cyclophosphamide. Patients with high-risk disease and donor availability were allowed to proceed to allogeneic HCT. The EFS and OS rates at 42 months were 55% and 60%, respectively. When data from patients who underwent transplantation at first CR were censored, the DFS rates at 42 months were 52% for patients with high-risk disease and 68% for patients with standard-risk disease (risk assignment based on GRAALL protocol); these DFS outcomes by risk groups were similar to outcomes using the MRC UKALL/ECOG definition for risk classification.²¹² Advanced age was predictive of poorer survival outcomes on this study; the OS rate at 42 months was 41% for patients older than 45 years compared with 66% for those aged 45 years or younger. Moreover, compared to the younger cohort, patients older than 45 years had a higher cumulative incidence of therapy-related deaths (23% vs. 5%) and deaths in first CR (22% vs. 5%).²¹² Thus, it seems that the benefit of this pediatric-inspired regimen outweighed the risks for therapy-related deaths only for those patients up to 45 years of age with Ph-negative ALL.

USC ALL Regimen Based on CCG-1882 Regimen

The USC ALL trial based on the pediatric CCG-1882 regimen has studied the regimen of daunorubicin, vincristine, prednisone, and methotrexate with augmented pegaspargase in patients between the ages of 18 years and 57 years of age with newly diagnosed ALL (n = 51).²¹³ The augmented arm included one long-lasting pegaspargase dose in each cycle of the 6 total scheduled doses. Each dose of pegaspargase (2000 IU/m² IV) was preceded with

hydrocortisone for hypersensitivity prophylaxis followed by 1 to 2 weeks of oral steroids. Patients on this trial received a mean of 3.8 doses per patient with 45% of patients receiving all 6 doses, while 20% of patients discontinued treatment based on toxicity. The 7-year OS was 51% (58% of these patients were Ph-negative) and the 7-year DFS was 58%. The dose of pegaspargase was lower than the FDA-approved dose of 2500 IU/m² and adjustments to the dosing interval were made to be greater than or equal to 4 weeks. This deviated from the pediatric protocol to account for the difference in drug enzymatic activity in adults. Study data suggest that adaptation of the pediatric regimen to the adult population may be feasible with modifications to reduce toxicity.

CALGB 10403 Regimen

A multicenter phase II Intergroup study (CALGB 10403) is currently ongoing to evaluate a pediatric-inspired regimen in the treatment of AYA patients with Ph-negative ALL. One of the study objectives is to compare the outcomes of patients treated in this trial with those of a similar group of patients (in regard to age and disease characteristics) treated by pediatric oncologists in the COG trial (AALL-0232). The treatment protocol includes a 4-drug induction regimen with intrathecal cytarabine and intrathecal methotrexate, consolidation, interim maintenance, delayed intensification, maintenance (for 2–3 years), and radiotherapy (for patients with testicular or CNS disease or those with T-cell ALL). Early results from 296 evaluable patients (median age, 24 years; range 17–39 years), report 70 deaths and 87 patients still on protocol therapy.²¹⁴

The median EFS is 59.4 months (95% CI, 38.4 months to NR) and the 2-year EFS rate is 66% (95% CI, 60%–72%). Patients with negative MRD on day 28 of induction had a 100% EFS ($P = .0006$). It was also noted that patients with Ph-like signatures had a significantly lower 2-

year EFS compared to those without Ph-like disease (52% vs. 81%; $P = .04$).

COG AALL 0434 Regimen

For patients with T-cell ALL, the addition of nelarabine may be a promising approach. Nelarabine is a nucleoside metabolic inhibitor and a prodrug of ara-G, approved for the treatment of patients with T-cell ALL with disease that has not responded to or that has relapsed after at least 2 chemotherapy regimens.²¹⁵ This drug is currently under evaluation as part of frontline chemotherapy regimens in AYA patients with T-cell ALL. The safety results from the randomized phase III COG study (AALL-0434) of the augmented BFM chemotherapy regimen, with or without nelarabine, showed that the toxicity profiles were similar between patients with high-risk T-cell ALL who received nelarabine ($n = 47$) and those who did not ($n = 47$).²¹⁶ No significant differences were observed in the occurrence of neurologic adverse events between these groups, including peripheral motor neuropathy, peripheral neuropathy, or CNS neurotoxicity. The incidence of adverse events such as febrile neutropenia and elevation of liver enzymes was also similar between treatment groups. These initial safety data suggest that nelarabine may be better tolerated in frontline regimens than in the relapsed/refractory setting.²¹⁶ Results from the efficacy phase of this study are awaited.

Hyper-CVAD with or without Rituximab

The hyper-CVAD regimen constitutes another commonly used ALL treatment regimen for adult patients. A phase II study from MDACC evaluated hyper-CVAD in adolescents and adults with previously untreated ALL ($n = 288$; median age, 40 years; range, 15–92 years; Ph-positive in 17%).⁹⁶ The median OS for all patients was 32 months and the 5-year OS rate was 38%, with a median follow-up of 63 months. Among patients who experienced a CR (92% of all patients), the 5-year CR duration rate was 38%.⁹⁶ Death during induction therapy occurred in

5% of patients, and was more frequent among patients aged 60 years or older. Among the patients with Ph-negative ALL ($n = 234$), the 5-year OS rate was 42%.⁹⁶

Based on retrospective analyses of data from adults with B-cell ALL treated in clinical trials, CD20 positivity (generally defined as CD20 expression on >20% of blasts) was found to be associated with adverse outcomes measured by a higher cumulative incidence of relapse, decreased CR duration, or decreased survival.^{32,217} Given the prognostic significance of CD20 expression in these patients, treatment regimens incorporating the CD20 monoclonal antibody rituximab have been evaluated. A phase II study from MDACC evaluated hyper-CVAD with or without rituximab in previously untreated patients with Ph-negative B-lineage ALL ($n = 282$; median age, 41 years; range, 13–83 years).¹⁴¹ Among the subgroup of patients with CD20-positive ALL who were treated with hyper-CVAD combined with rituximab, the 3-year CR duration and OS rates were 67% and 61%, respectively. In addition, among the younger patients (age <60 years) with CD20-positive disease, modified hyper-CVAD plus rituximab resulted in a significantly improved CR duration (70% vs. 38%; $P < .001$) and OS rate (75% vs. 47%; $P = .003$) compared with the standard hyper-CVAD regimen without rituximab.¹⁴¹ No significant differences in outcomes with the addition of rituximab were noted for the subgroup of patients with CD20-negative disease. Notably, older patients (age ≥ 60 years) with CD20-positive disease did not seem to benefit from the addition of rituximab, partly because of a high incidence of death in CR.

Hematopoietic Cell Transplant

For AYA patients in first CR, allogeneic HCT may be considered for high-risk cases, particularly for patients with disease that is MRD positive or patients with elevated WBC counts, or patients with B-ALL and poor-risk cytogenetics (eg, hypodiploidy, *MLL* rearrangement) at

diagnosis. A large multicenter trial (LALA-94 study) evaluated the role of postinduction HCT as one of the study objectives in adolescent and adult ALL patients receiving therapy for previously untreated ALL (n = 922; median age, 33 years; range, 15–55 years).⁶⁶ Patients were stratified into 4 risk groups: 1) Ph-negative standard-risk disease [defined as achievement of CR after 1 course of chemotherapy; absence of CNS disease; absence of t(4;11), t(1;19), or other 11q23 rearrangements; WBC count <30 × 10⁹/L]; 2) Ph-negative high-risk ALL (defined as patients with non-standard-risk disease and without CNS involvement); 3) Ph-positive ALL; and 4) evidence of CNS disease. After induction therapy, patients with Ph-negative high-risk ALL were eligible to undergo allogeneic HCT if a matched sibling donor was available; those without a sibling donor were randomized to undergo autologous HCT or chemotherapy alone.⁶⁶ Among the subgroup of patients with Ph-negative high-risk ALL (n = 211), the 5-year DFS and OS rates were 30% (median, 16 months) and 38% (median, 29 months), respectively. Based on intent-to-treat analysis, outcomes in patients with Ph-negative high-risk ALL were similar for autologous HCT (n = 70) and chemotherapy alone (n = 59) in terms of median DFS (15 vs. 11 months), median OS (28 vs. 26 months), and 5-year OS rate (32% vs. 21%).⁶⁶ Outcomes were improved in patients with Ph-negative high-risk ALL and those with CNS involvement allocated to allogeneic HCT. The median DFS was 21 months for these patients, and the median OS has not yet been reached; the 5-year OS rate was 51%.⁶⁶ Thus, it appears that in patients with Ph-negative high-risk disease, allogeneic HCT in first CR improved DFS outcomes, whereas autologous HCT did not result in significant benefit compared with chemotherapy alone.

In the PETHEMA ALL-93 trial, adult patients with high-risk ALL [defined as having at least one of the following criteria: 30–50 years of age;

WBC count ≥25 × 10⁹/L; presence of t(9;22), t(4;11), or other 11q rearrangements; and t(1;19)] received postremission induction therapy (n = 222 eligible; median age, 27 years; range, 15–50 years) with allogeneic HCT (n = 84; if matched related donor available), autologous HCT (n = 50), or chemotherapy alone (n = 48).²¹⁸ Based on intent-to-treat analysis of data from patients with Ph-negative high-risk disease, no significant advantage was observed in a donor versus no-donor comparison of median DFS (21 months vs. 38 months), median OS (32 months vs. 67 months), 5-year DFS rate (37% vs. 46%), or 5-year OS rate (40% vs. 49%). In addition, when the analysis was conducted based on the actual postremission treatment received, no significant differences were noted between treatment arms for 5-year DFS rates (50% for allogeneic HCT; 55% for autologous HCT; and 54% for chemotherapy alone).²¹⁸

The role of allogeneic HCT in adults with ALL was also evaluated in the large multicenter MRC UKALL XII/ECOG E2993 study (n = 1913; age 15–59 years).⁶⁷ In this study, high risk was defined as 35 years of age or older; time to CR greater than 4 weeks from induction; elevated WBC counts (>30 × 10⁹/L for B-cell ALL; >100 × 10⁹/L for T-cell ALL); or the presence of Ph chromosome. All other patients were considered to be standard risk. Patients experiencing a remission with induction therapy were eligible to undergo allogeneic HCT if a matched sibling donor was available or, in the absence of a sibling donor, were randomized to undergo autologous HCT or chemotherapy. The 5-year OS rate was higher for patients randomized to chemotherapy alone compared with autologous HCT (46% vs. 37%; *P* = .03). A donor versus no-donor comparison in all patients with Ph-negative ALL showed that the 5-year OS rate was significantly higher in the donor group than in the no-donor group (53% vs. 45%; *P* = .01). This advantage in OS outcomes for the donor group was observed for patients with standard risk (62% vs. 52%;

$P = .02$) but not for those with Ph-negative high-risk disease (41% vs. 35%).⁶⁷ This was partly because of the high rate of non-relapse mortality observed with the donor group compared with the no-donor group in patients with high-risk disease (36% vs. 14% at 2 years). Among patients with standard risk, the non-relapse mortality rate at 2 years was 19.5% for the donor group and 7% for the no-donor group. Relapse rate was significantly lower in the donor group than in the no-donor group for both patients with standard risk (24% vs. 49%; $P < .001$) and those with high risk (37% vs. 63%; $P < .001$).⁶⁷ Nevertheless, the high non-relapse mortality rate in the donor group among patients with high-risk disease seemed to diminish the advantage of reduced risk for relapse in this group. This study suggested that allogeneic HCT in first CR was beneficial in patients with standard-risk ALL.

The benefit of matched sibling allogeneic HCT in adult patients with standard-risk ALL was also reported by the HOVON cooperative group. In a donor versus no-donor analysis of patients with standard-risk ALL undergoing postremission therapy with matched sibling allogeneic HCT or autologous HCT, the donor arm was associated with a significantly reduced 5-year relapse rate (24% vs. 55%; $P < .001$) and a higher 5-year DFS rate (60% vs. 42%; $P = .01$) compared with the no-donor arm.²¹⁹ In the donor group, the non-relapse mortality rate at 5 years was 16% and the 5-year OS rate was 69%.²¹⁹

As evidenced by the previously described studies, matched sibling HCT has been established as a valuable treatment strategy for patients with high-risk Ph-negative ALL, but more recently studies have examined the role of URD transplants. In a retrospective analysis of 169 patients who underwent URD HCT during first CR, 60 patients (36%) had one poor prognostic factor and 97 (57%) had multiple risk factors. The 5-year survival was 39%, which is higher than survival reported in studies of high-risk patients receiving chemotherapy alone.²²⁰ The most significant

percentage of treatment-related mortality occurred in patients who were given mismatched donors compared to partially or well-matched donors. There was no significant difference in outcome between older and younger patients, suggesting that URD transplants may be an option for older patients. In a follow-up retrospective study by the same group, reduced-intensity conditioning (RIC) was evaluated to lower treatment-related mortality.²²¹ RIC conditioning most commonly comprised busulfan (9 mg/kg or less), melphalan (150 mg/m²), low-dose total body irradiation (TBI) (less than 500 cGy single dose or less than 800 cGy fractionated), or fludarabine plus TBI of 200 cGy. RIC is more prominent in the treatment of older patients; therefore, the median age for patients receiving full intensity (FI) conditioning was 28 years (range, 16–62 years), and for patients receiving RIC, the median age was 45 years (range, 17–66 years). Despite the variation in age, results from the study have shown no difference in relapse (35% vs. 26%, $P = .08$) or in treatment-related mortality (FI 33%; 95% CI, 31%–36% vs. RIC 32%; 95% CI, 23%–43%; $P = .86$) at 3 years.²²¹ The 3-year survival for HCT was similar following first CR (FI 51%; 95% CI, 48%–55% vs. RIC 45%; 95% CI, 31–59%) and second CR (FI 33%; 95% CI, 30%–37% vs. RIC 28%; 95% CI, 14%–44%). The DFS was similar in both groups following first CR (FI 49%; 95% CI, 45%–53% vs. RIC 36%; 95% CI, 23%–51%) and in second CR (FI 32%; 95% CI, 29%–36% vs. RIC 27%; 95% CI, 14%–43%).²²¹

A systematic review and meta-analysis of published randomized trials on postremission induction therapy in adults with ALL reported a significant reduction in all-cause mortality with allogeneic HCT in first CR (RR, 0.88; 95% CI, 0.80–0.97) compared with autologous HCT or chemotherapy.²²² A subgroup analysis showed a significant survival advantage with allogeneic HCT in standard-risk ALL, whereas a nonsignificant advantage was seen in high-risk ALL.²²² Autologous HCT

in first remission was not shown to be beneficial relative to chemotherapy in several large studies and meta-analyses.^{66,67,222,223}

Initial Treatment in Adults with Ph-Negative ALL

CALGB 8811 Larson Regimen

Typically, induction regimens for adult ALL are also based on a backbone of vincristine, corticosteroids, and anthracyclines. The CALGB 8811 trial evaluated a 5-drug induction regimen (comprising vincristine, daunorubicin, prednisone, L-asparaginase, and cyclophosphamide) as part of an intensive chemotherapy regimen for patients with previously untreated ALL (n = 197; Ph-positive in 29%; median age, 32 years; range, 16–80 years).⁹¹ The median OS for all patients was 36 months, after a median follow-up of 43 months. Among patients who experienced a CR (85% of all patients), the median remission duration was 29 months. The estimated 3-year OS rate was higher for the subgroup of patients younger than 30 years compared with those aged 30 to 59 years or patients 60 years and older (69% vs. 39% vs. 17%; *P* < .001). Among the subgroup of patients who had both Ph-negative and BCR-ABL–negative disease (n = 57), median OS was 39 months and the 3-year OS rate was 62%.⁹¹

Linker 4-Drug Regimen

Linker et al²²⁴ evaluated an intensified chemotherapy regimen that incorporated a 4-drug induction regimen (comprising vincristine, daunorubicin, prednisone, and asparaginase) in adolescent and adult patients with ALL (n = 84; Ph-positive in 16%; median age, 27 years; range, 16–59 years). The 5-year EFS and OS rates for all patients were 48% and 47%, respectively. Among the patients who experienced a CR (93% of all patients), the 5-year EFS rate was 52%. The 5-year EFS rate was 60% for the subgroup of patients without high-risk features (n = 53).²²⁴

MRC UKALL XII/ECOG E2993

In one of the largest multicenter prospective trials conducted to date (MRC UKALL XII/ECOG E2993 study), previously untreated adolescent and adult patients (n = 1521; age 15–59 years) received induction therapy consisting of vincristine, daunorubicin, prednisone, and L-asparaginase for 4 weeks (phase I) followed by cyclophosphamide, cytarabine, oral 6-MP, and intrathecal methotrexate for 4 weeks (phase II).⁸² After completion of induction therapy, patients who experienced a CR received intensification therapy with 3 cycles of high-dose methotrexate (with standard leucovorin rescue) and L-asparaginase. After intensification, those younger than 50 years who had an HLA-compatible sibling underwent allogeneic HCT; all others were randomized to receive autologous HCT or consolidation/maintenance treatment.⁸² For Ph-negative disease, high risk was defined as having any of the following factors: age 35 years or older; time to CR greater than 4 weeks; or elevated WBC count (>30 × 10⁹/L for B-cell lineage; >100 × 10⁹/L for T-cell lineage). All other Ph-negative patients were considered to have standard-risk disease. The 5-year OS rate for all patients with Ph-negative ALL was 41%; the OS rates for the subgroups with standard risk (n = 533) and high risk (n = 590) were 54% and 29%, respectively.⁸² In the subgroup of patients with T-cell ALL (n = 356), the 5-year OS rate was 48%; the OS rate was improved to 61% for those with a matched sibling donor, primarily because of a lower incidence of cumulative relapse.²²⁵ Among the patients with T-cell ALL, those with complex cytogenetic abnormalities had a poor 5-year OS outcome (19%).

Hyper-CVAD with or without Rituximab

Studies evaluating hyper-CVAD with or without rituximab have included both AYA and adult patients.^{96,141} For discussion of these studies, refer to previous section (see *Initial Treatment of AYAs with Ph-Negative ALL*).

Hematopoietic Cell Transplant

Studies evaluating HCT in first CR for AYA patients with Ph-negative ALL have generally been inclusive of adult patients and therefore have been discussed previously (see *Initial Treatment in AYAs with Ph-Negative ALL*). More aggressive therapies are being considered for older or less fit patients. A retrospective study of 576 adults, 45 years of age or older, compared RIC or myeloablative conditioning allogeneic HCT from HLA-matched siblings.²²⁶ Patients who received RIC (n = 127) versus myeloablative conditioning (n = 449) did not show any statistically significant difference in leukemia-free survival ($P = .23$; HR, 0.84) thereby supporting the incorporation of more aggressive treatments for this population.²²⁶

Treatment of Relapsed Ph-Negative ALL

Despite major advances in the treatment of childhood ALL, approximately 20% of pediatric patients experience relapse after initial CR to frontline treatment regimens.²²⁷⁻²²⁹ Among those who experience relapse, only approximately 30% experience long-term remission with subsequent therapies.^{142,230,231} Based on a retrospective analysis of historical data from COG studies (for patients enrolled between 1998 and 2002; n = 9585), early relapse (<18 months from diagnosis) was associated with very poor outcomes, with an estimated 5-year survival (from time of relapse) of 21%.²²⁷ For cases of isolated bone marrow relapse, the 5-year survival estimates among early (n = 412), intermediate (n = 324), and late (n = 387) relapsing disease were 11.5%, 18.0%, and 43.5%, respectively ($P < .0001$). Intermediate relapse was defined as relapse occurring between 18 and 36 months from time of diagnosis; late cases were defined as relapse occurring 36 months or more from time of diagnosis. For cases of isolated CNS relapse, the 5-year survival estimates among early (n = 175), intermediate (n = 180), and late (n = 54) relapsing disease were 43.5%,

68.0%, and 78.0%, respectively ($P < .0001$).²²⁷ Based on multivariate analysis (adjusted for both timing and site of relapse), age (>10 years), presence of CNS disease at diagnosis, male gender, and T-cell lineage disease were found to be significant independent predictors of decreased survival after relapse.²²⁷ In a separate analysis of data from one of the above COG studies (CCG-1952), the timing and site of first relapse were significantly predictive of EFS and OS outcomes, even among the patients with standard-risk ALL (n = 347; based on NCI criteria: age 1 to <10 years of age and WBC count $<50 \times 10^9/L$).²³² Early bone marrow relapse (duration of first CR <36 months) was associated with significantly shorter estimated 3-year EFS (30% vs. 44.5%; $P = .002$) and OS (35% vs. 58%; $P = .001$) rates compared with late bone marrow relapse.²³² Similarly, early isolated extramedullary relapse (duration of first CR <18 months) was associated with significantly shorter estimated 3-year EFS (37% vs. 71%; $P = .01$) and OS (55% vs. 81.5%; $P = .039$) rates compared with late extramedullary relapse. In a multivariate regression analysis, early bone marrow and extramedullary relapse were independent predictors of poorer EFS outcomes.²³²

Data from patients with disease relapse after frontline therapy in the MRC UKALL XII/ECOG E2993 study and PETHEMA studies showed that the median OS after relapse was only 4.5 to 6 months; the 5-year OS rate was 7% to 10%.^{164,165} Approximately 20% to 30% of patients experience a second CR with second-line therapies.^{165,167} Factors predictive of more favorable outcomes after subsequent therapies included younger age and a first CR duration of more than 2 years.^{154,165} Among younger patients (age <30 years) whose disease relapsed after experiencing a first CR duration longer than 2 years with frontline treatment in PETHEMA trials, the 5-year OS rate from the time of first relapse was 38%.¹⁶⁵

Clofarabine

Clofarabine is a nucleoside analog approved for the treatment of pediatric patients (aged 1–21 years) with ALL that is relapsed or refractory after at least 2 prior regimens.²³³ In a phase II study of single-agent clofarabine in heavily pretreated pediatric patients with relapsed or refractory ALL (n = 61; median age, 12 years; range, 1–20 years; median 3 prior regimens), the response rate (CR + CR without platelet recovery [CRp]) was 20%.²³⁴ Among the patients with responding disease, the median duration of remission was 29 weeks. Although the median OS for all patients was only 13 weeks, the median OS for patients with a CR had not yet been reached at the time of publication; median OS was 54 weeks for patients with a CRp and 30 weeks for patients with a partial remission.²³⁴ Single-agent clofarabine in the relapsed/refractory setting has been associated with severe liver toxicities (generally reversible) and frequent febrile episodes including grade 3 or 4 infections and febrile neutropenia.^{234,235}

In a small phase II study evaluating the combination of clofarabine with cyclophosphamide and etoposide in pediatric patients with refractory or multiple relapsed ALL (n = 25; median age, 12.5 years), the regimen resulted in a CR rate of 52% (plus an additional 4% CRp), with an 18-month OS probability of 39% among responders.²³⁶ In subsequent, small phase II studies in pediatric patients (age 1–21 years) with relapsed/refractory ALL, this combination induced response rates (CR plus CRp) of 42% to 44%.^{237,238} A multicenter retrospective study of data from pediatric patients treated with clofarabine outside of the clinical trial setting (n = 23; age 0–17 years) reported that among those treated with the combination of clofarabine, cyclophosphamide, and etoposide (n = 18), the CR rate was 56%.²³⁹ The combination regimen of clofarabine, cyclophosphamide, and etoposide has been associated with prolonged and severe myelosuppression, febrile episodes or severe infections (including sepsis or septic shock), mucositis, and liver

toxicities including fatal veno-occlusive disease (the latter occurring in the post-allogeneic HCT setting).²³⁷⁻²³⁹ Moreover, data are very limited with this combination regimen in adult patients with ALL. Because the use of this regimen requires close monitoring and intensive supportive care measures, patients should only be treated in centers with expertise in the management of ALL.

Clofarabine has also been shown to be active in combination with other chemotherapy regimens in adults with relapsed/refractory disease. In a study from GRAALL, clofarabine in combination with conventional chemotherapy (cyclophosphamide, or a more intensive regimen with dexamethasone, mitoxantrone, etoposide, and asparaginase) yielded a CR rate of 44% in patients with relapsed/refractory ALL (n = 55); the median OS was 6.5 months after a short median follow-up of 6 months.²⁴⁰ The most common grade 3 or 4 toxicities included infection (58%) and liver toxicities (24%).²⁴⁰

Augmented Hyper-CVAD

A phase II study from MDACC evaluated an augmented hyper-CVAD regimen (that incorporated asparaginase, intensified vincristine, and intensified dexamethasone) as therapy in adults with relapsed/refractory ALL (n = 90; median age, 34 years; range, 14–70 years; median 1 prior regimen).²⁴¹ Among evaluable patients (n = 88), the CR rate was 47%; an additional 13% experienced a CRp and 5% experienced a partial remission. The 30-day mortality rate was 9%, and was lower among the subgroup who received pegaspargase than those who received L-asparaginase (1% vs. 12%). Median remission duration was 5 months. The median OS for all evaluable patients was 6.3 months; median OS was 10.2 months for patients who experienced a CR. In this study, 32% of patients were able to proceed to HCT.²⁴¹

Nelarabine

Nelarabine is a nucleoside analog that is currently approved for the treatment of patients with T-cell ALL who have not experienced disease response to or who have relapsed disease after at least 2 chemotherapy regimens.²¹⁵ A phase II study of nelarabine monotherapy in children and adolescents with relapsed/refractory T-cell ALL or T-cell non-Hodgkin's lymphoma (n = 121) showed a 55% response rate among the subgroup with T-cell ALL with first bone marrow relapse (n = 34) and a 27% response rate in the subgroup with a second or greater bone marrow relapse (n = 36).¹⁴² Major toxicities included grade 3 or higher neurologic (both peripheral and CNS) adverse events in 18% of patients. Nelarabine as single-agent therapy was also evaluated in adults with relapsed/refractory T-cell ALL or T-cell lymphoblastic leukemia in a phase II study (n = 39; median age, 34 years; range, 16–66 years; median 2 prior regimens; T-cell ALL, n = 26).¹⁴⁴ The CR rate (including CR with incomplete blood count recovery [CRi]) was 31%; an additional 10% of patients experienced a partial remission. The median DFS and OS were both 20 weeks and the 1-year OS rate was 28%. Grade 3 or 4 myelosuppression was common, but only one case of grade 4 CNS toxicity (reversible) was observed.¹⁴⁴

Vincristine Sulfate Liposomal Injection

Vincristine remains an important part of the backbone of chemotherapy agents used in ALL treatment. Vinca alkaloids are known to be associated with neurologic toxicities, generally limiting their use at higher doses. Vincristine sulfate liposome injection (VSLI) is a novel nanoparticle formulation of vincristine encapsulated in sphingomyelin and cholesterol liposomes; the liposome encapsulation prolongs the exposure of active drug in the circulation and may allow for delivery of increased doses of vincristine without increasing toxicities.^{242,243} VSLI was recently evaluated in an open-label, multicenter, phase II study in adult patients with Ph-negative ALL (n = 65; median age, 31 years;

range, 19–83 years) in second or greater relapse, or with disease that progressed after 2 or more prior lines of therapy (RALLY study).²⁴⁴ Approximately 50% of patients had received 3 or more prior lines of therapy. In addition, 48% of patients had undergone prior HCT, and all patients had previously been treated with a regimen containing standard vincristine. The CR (CR + CRi) rate with single-agent VSLI was 20%. The median duration of CR was 23 weeks (range, 5–66 weeks) and the median OS for all patients was 20 weeks (range, 2–94 weeks); median OS for patients achieving a CR was 7.7 months.²⁴⁴ The incidence of early induction death (30-day mortality rate) was 12%.²⁴⁴ These outcomes appeared favorable compared with published historical data in patients with Ph-negative ALL treated with other agents at second relapse (n = 56; CR rate, 4%; median OS, 7.5 weeks; early induction death, 30%).^{244,245} The most common grade 3 or greater treatment-related toxicities with VSLI included neuropathy (23%), neutropenia (15%), thrombocytopenia (6%), anemia (5%; no grade 4), and TLS (5%). Febrile neutropenia occurred in 3% of patients (no grade 4).²⁴⁴ Based on data from the RALLY study, VSLI was approved (in September 2012) by the FDA for the treatment of adult patients with Ph-negative ALL in second or greater relapse or who have disease that has progressed after 2 or more therapies.²⁴⁶

Blinatumomab

Blinatumomab is a component of the growing arsenal of immunotherapies for the treatment of cancer. Blinatumomab is a bispecific anti-CD3/CD19 monoclonal antibody that showed high CR rates (69%; including rapid MRD-negative responses) in patients with relapsed/refractory B-precursor ALL (n = 25).^{247,248} In an earlier phase II study, blinatumomab was shown to eliminate residual disease in 80% of patients with relapsed or MRD-positive B-precursor ALL after intensive chemotherapy (N = 21; n = 20 evaluable).²⁰³ After a median follow-up of 33 months, the hematologic RFS rate was 61%. Blinatumomab was

approved by the FDA based on data from a large phase II confirmatory study of 189 patients with Ph-negative relapsed or refractory B-cell ALL that demonstrated a CR or CRp in 43% of patients within the first 2 cycles of treatment.^{249,250} A profound improvement was seen in the treatment of patients with relapsed/refractory ALL, a population that has a historically poor prognosis and limited treatment options; however, there are significant and unique side effects to this treatment compared to the current standard-of-care regimens. Cytokine release syndrome is a serious adverse event with peak cytokine levels in the first 2 days following initiation of blinatumomab infusion.²⁵¹ Symptoms of cytokine release syndrome include pyrexia, headache, nausea, asthenia, hypotension, increased alanine aminotransferase, increased aspartate aminotransferase, and increased total bilirubin. Neurologic toxicities have been reported in 50% of patients (median onset, 7 days).²⁵¹ Grade 3 or higher neurologic toxicities have occurred in 15% of patients. Serious risks may occur with preparation or administration errors.²⁵¹ The incidence of adverse events can be reduced with patient monitoring for early intervention at the onset of symptoms. However, the serious nature of these events underscores the importance of receiving treatment in a specialized cancer center that has experience with blinatumomab.

CAR T-cells

One of the early treatments for patients with advanced ALL included adoptive cell therapy to induce a graft-versus-leukemia effect through allogeneic HCT or DLI. However, this method resulted in a significant risk of GVHD. To circumvent this issue, current advances are focused on the use of the patient's own T-cells to target the tumor. The generation of CAR T-cells to treat ALL is a significant advancement in the field.²⁵²⁻²⁵⁴ Briefly, T-cells from the patient are harvested and engineered with a receptor that targets a cell surface tumor-specific antigen (eg, CD19 antigen on the surface of leukemic cells). The ability

of CAR T-cells to be reprogrammed to target any cell-surface antigen on leukemic cells is advantageous and avoids the issue of tumor evasion of the immune system via receptor down regulation.²⁵⁵ The viral vector in CAR T-cells causes T-cell expansion and proliferation following antigen recognition, and once modified, CAR T-cells can be expanded *ex vivo* for approximately two weeks to produce high numbers before IV infusion back into the patient.²⁵⁶ Following infusion, debulking of tumors occurs in less than a week and these cells may remain in the body for extended periods of time to provide immunosurveillance against relapse.

There are several clinical trials using CAR T-cells that differ in the receptor construct for patients with relapsed or refractory ALL. The modified receptor, termed 19-28z, demonstrated an overall CR in 14 out of 16 patients with relapsed or refractory B-cell ALL following infusion with CAR T-cells.²⁰⁴ This average remission rate is significantly improved compared to the average remission rate for patients receiving standard-of-care chemotherapy following relapse (88% vs. approximately 30%).^{164,204,244,257} Furthermore, 7 out of 16 patients were able to receive an allogeneic HCT, suggesting that CAR T-cells may provide a bridge to transplant.²⁰⁴ No relapse has been seen in patients who had allogeneic HCT (follow-up, 2–24 months); however, 2 deaths occurred from transplant complications. In a recent abstract, follow-up data of adult patients enrolled on this trial (n = 24, 22 evaluable) showed a 91% CR rate after the infusion and 18 of these 20 patients achieved an MRD-negative CR.²⁵⁸ Out of the 13 patients who were transplant eligible, 10 underwent allogeneic HCT. The median follow-up was 7.4 months and a durable response, indicated by DFS past one year, was seen in 6 patients. The median OS was 9 months.

A second receptor construct that is defined by the alteration in the single chain variable fragment (scFv) of CD19 (anti-CD19 scFv/4-

1BB/CD3ζ) has shown similar results to the 19-28z CAR T-cells in terms of overall CR.²⁵⁹ These cells, more simply referred to as CTL019, were infused into 16 children and 4 adults with relapsed/refractory ALL; a CR following therapy was achieved in 14 patients.²⁵⁹ There was no response of the disease to treatment in 3 patients and disease response to therapy was still under evaluation for 3 patients.²⁵⁹ A follow-up study of 25 children and 5 adults showed a morphologic CR of 90% (27 out of 30) patients within a month of treatment and an OS of 78% (95% CI, 65%–95%) and EFS of 78% (95% CI, 51%–88%) at 6 months.²⁶⁰ There were 19 patients in sustained remission, of which 15 received no further therapy.

Inotuzumab Ozogamicin

Inotuzumab ozogamicin (InO) is an anti-CD22 monoclonal antibody-drug conjugate that has shown high CR rates (57%) in a phase II study in patients with relapsed/refractory ALL (n = 49).²⁶¹ In a phase III study comparing the efficacy and safety of InO to standard of care consisting of intensive chemotherapy, InO demonstrated higher CR/CRi (80.7% vs. 29.4%; $P < .001$), higher duration of remission (4.6 months vs. 3.1 months; $P = .03$) and higher MRD-negative rates (78.4% vs. 28.1%; $P < .001$).^{262,263} Similar to previous studies, InO had a higher rate of liver toxicities and veno-occlusive liver disease (15 patients vs. 1 patient). InO has received breakthrough therapy designation by the FDA, though it is not currently approved for any indication.

Other Regimens

Another regimen for advanced disease, comprising ifosfamide, etoposide, and mitoxantrone, was evaluated in a small phase II study in adult patients with relapsed or refractory ALL (n = 11); 8 patients (73%) experienced a CR, and the median DFS and OS durations from time of remission were 3.1 and 7.7 months, respectively.²⁶⁴ The combination of high-dose cytarabine and idarubicin was evaluated as a regimen in

adult patients with relapsed/refractory ALL (n = 29).²⁶⁵ In this study, 11 patients (38%) experienced a CR, and the median OS for patients with disease that responded to treatment was 8 months. Four patients who experienced a CR with this therapy proceeded to allogeneic HCT. The median OS for all patients in the study was 6 months.²⁶⁵

Hematopoietic Cell Transplant

Based on findings from evidence-based review of the published literature, the American Society for Blood and Marrow Transplantation guidelines recommend HCT over chemotherapy alone for adult patients with ALL experiencing a second CR.²⁶⁶ Several studies have shown that for AYA patients in second CR, allogeneic HCT may improve outcomes, particularly for patients who have early bone marrow relapse or have other high-risk factors, such as T-cell ALL.^{230,231,267} In a retrospective analysis of children and adolescents (age 1–18 years) with pre-B-cell ALL experiencing a second CR after bone marrow relapse, outcomes were compared between patients who underwent allogeneic HCT (n = 186) and those who received chemotherapy regimens in the POG trials (n = 188).²⁶⁷ The study showed that among patients with early bone marrow relapse (<36 months from time of diagnosis), TBI-containing allogeneic HCT was associated with significantly lower risks of a second relapse (relative risk, 0.49; 95% CI, 0.33–0.71; $P < .001$) or overall mortality (relative risk, 0.58; 95% CI, 0.41–0.83; $P = .003$) compared with chemotherapy regimens. This advantage with TBI-containing allogeneic HCT was not observed among the subgroup with a late first relapse (≥ 36 months), and no advantages were seen with the use of non-TBI-containing HCT regimens regardless of the timing of first relapse.²⁶⁷ Thus, among patients with pre-B-cell ALL in second CR after early bone marrow relapse, TBI-containing allogeneic HCT may improve outcomes compared with chemotherapy alone; however, for patients with late bone marrow relapse, HCT may offer no advantage over chemotherapy regimens.

An earlier BFM study (BFM-87) evaluated long-term outcomes with intensive chemotherapy or HCT (for poor prognosis disease) in patients with ALL relapsing after frontline treatment ($n = 207$; age up to 18 years).²³⁰ In this study, patients with poor prognosis included those with early bone marrow relapse (defined as relapse occurring during therapy or up to 6 months after completion of frontline treatment) or T-cell ALL. The 15-year EFS and OS rates for the entire patient cohort were 30% and 37%, respectively.²³⁰ The 10-year EFS rate was significantly higher among the patients who received allogeneic HCT after second CR ($n = 27$) compared with those who received chemotherapy/radiotherapy only ($n = 145$; 59% vs. 30%; $P = .026$). All recipients of allogeneic HCT received TBI as part of the conditioning regimen. Based on multivariate regression analysis, timing and site of relapse (with early relapse and isolated bone marrow relapse associated with poor outcomes), T-cell lineage disease, and HCT were significant independent predictors of EFS outcomes.²³⁰

The more recent BFM study (BFM-90) in patients with ALL relapsing after frontline therapy ($n = 525$; age 1–18 years) further confirmed the benefits of allogeneic HCT in second CR.²³¹ In this study, the timing of first relapse was defined as very early (within 18 months from initial diagnosis), early (>18 months from initial diagnosis and <6 months after completion of frontline therapy), and late (>6 months after completion of frontline treatment). The overall 10-year EFS and OS rates were 30% and 36%, respectively.²³¹ Among the patients with high-risk disease (ie, presence of early isolated bone marrow relapse, early combined bone marrow and extramedullary relapse, very early bone marrow relapse, or T-cell lineage ALL regardless of relapse timing), patients who received chemoradiotherapy alone had a significantly shorter 10-year EFS ($n = 76$; 20%) than those who received HCT ($n = 84$; 33%; $P < .005$) or the subgroup of patients who received HLA-compatible allogeneic HCT ($n =$

53; 40%; $P < .001$). This EFS benefit with HCT (or with allogeneic HCT) was not observed among the subgroup of patients with intermediate-risk disease (ie, late bone marrow relapse or isolated extramedullary relapse regardless of relapse timing). The preferred conditioning regimen for HCT in this study included TBI.²³¹

Seemingly contradictory data was reported in the COG CCG-1952 study that showed prognosis after early bone marrow relapse in patients with standard-risk ALL (age 1 to <10 years of age and WBC count $<50 \times 10^9/L$) remained poor with no apparent advantage of HCT, regardless of timing (eg, early or late) of bone marrow relapse.²³² No significant differences were observed in the EFS or OS rates between treatment with HCT ($n = 77$) or chemotherapy ($n = 81$); the 2-year estimated EFS rates with HCT and chemotherapy were 49.5% and 49%, respectively ($P = .39$). Moreover, no significant differences in EFS rates were observed in the subgroup of patients with early or late bone marrow relapses.²³² However, data were not available on the conditioning regimen used for HCT in this study for comparison with other trials.

A recent meta-analysis of 13 studies ($n = 2962$ patients) with Ph-negative ALL compared standard postremission therapy to determine if there is an advantage in survival among allogeneic HCT, autologous HCT, or chemotherapy.²⁶⁸ In this analysis, patients younger than 35 years of age had a significant survival advantage when receiving a matched sibling donor compared to autologous HCT (OR, 0.79; 95% CI, 0.70–0.90; $P = .0003$). This advantage was not maintained in patients who were 35 years of age or older (OR, 1.01; 95% CI, 0.85–1.19; $P = .9$), a difference attributed to a higher absolute risk of non-relapse mortality for older patients. There was a trend towards an inferior survival in patients receiving autologous HCT compared to chemotherapy (OR, 1.18; 95% CI, 0.99–1.41; $P = .06$), though statistical significance was not reached. Similarly, a meta-analysis including 14

trials found that the 5-year leukemia-free survival was higher following allogeneic transplantation (45%; 95% CI, 38%–51%) compared to autologous transplant or chemotherapy (30%; 95% CI, 23%–37%).²⁶⁹

NCCN Recommendations for Ph-Negative ALL

AYA Patients (Age 15–39 Years) with Ph-Negative ALL

The panel recommends that AYA patients with Ph-negative ALL (regardless of risk group) be treated in a clinical trial, where possible. In the absence of an appropriate clinical trial, the recommended induction therapy should comprise multiagent chemotherapy regimens preferably based on pediatric-inspired protocols, such as the CCG-1961, PETHEMA ALL-96, GRAALL-2003, COG AALL-0434 (for T-cell ALL), DFCI-00-01, CCG-1882, or the ongoing CALGB 10403 regimens. Other multiagent chemotherapy protocols, including hyper-CVAD (with or without rituximab), are also recommended.¹⁴¹ Treatment regimens should include adequate CNS prophylaxis for all patients. It is important to adhere to the treatment regimens for a given protocol in its entirety. Testing for *TPMT* gene polymorphism should be considered for patients receiving 6-MP as part of maintenance therapy, especially in those who experience severe bone marrow toxicities.

For patients experiencing a CR following initial induction therapy, monitoring for MRD should be initiated (see *NCCN Recommendations for MRD Assessment*). In these patients, continuation of the multiagent chemotherapy protocol for consolidation and maintenance would be appropriate (particularly for patients with MRD-negative remission after induction). For patients with residual disease as assessed with MRD assays or for those with high-risk cytogenetic features (ie, hypodiploidy, complex karyotype, *MLL* rearrangements), consolidation with allogeneic HCT may also be considered. The benefit of allogeneic HCT in the setting of MRD-positive remission is currently unclear. For AYA patients experiencing less than a CR after initial induction therapy (ie, presence

of primary refractory disease), the treatment approach would be similar to that for patients with relapsed/refractory ALL.

For patients with relapsed/refractory disease after an initial CR, the approach to second-line treatment may depend on the duration of the initial response. For late relapses (ie, relapse occurring ≥ 36 months from initial diagnosis), re-treatment with the same induction regimen may be a reasonable option. Participation in a clinical trial is preferred, where possible. In the absence of an appropriate trial, the patient may be considered for second-line therapy with induction regimens not previously used, subsequent chemotherapy (with regimens containing clofarabine [for B-cell ALL], nelarabine [for T-cell ALL], VSLI, cytarabine, or alkylating agents), or allogeneic HCT. For patients with Ph-negative precursor B-cell ALL, blinatumomab is a preferred option.

Adult Patients (Age ≥ 40 Years) with Ph-Negative ALL

For adult patients with Ph-negative ALL, the panel recommends treatment in a clinical trial, where possible. In the absence of an appropriate clinical trial, the recommended treatment approach would initially depend on the patient's age and/or presence of comorbid conditions. Treatment regimens should include adequate CNS prophylaxis for all patients, and a given treatment protocol should be followed in its entirety, from induction therapy to consolidation/delayed intensification to maintenance therapy. Again, testing for *TPMT* gene polymorphism should be considered for patients receiving 6-MP as part of maintenance therapy, especially in those who develop severe bone marrow toxicities.

Although the age cutoff indicated in the guidelines has been set at 65 years, it should be noted that chronologic age alone is not a sufficient surrogate for defining fitness; patients should be evaluated on an

individual basis to determine fitness for therapy based on factors such as performance status, end-organ function, and end-organ reserve.

For relatively fit patients (age <65 years or patients with no substantial comorbidities), the recommended treatment approach is similar to that for AYA patients. Induction therapy should comprise multiagent chemotherapy such as those based on protocols from the CALGB 8811 study (Larson regimen), the Linker regimen, hyper-CVAD (with or without rituximab), or the MRC UKALL XII/ECOG E2993 study. For patients experiencing a CR after initial induction therapy, monitoring for MRD should be initiated (see *NCCN Recommendations for MRD Assessment*). In these patients, continuation of the multiagent chemotherapy protocol for consolidation and maintenance would be appropriate (particularly for patients with MRD-negative remission after induction). Consolidation with allogeneic HCT may be considered for patients with residual disease as measured by MRD assays, although the benefit of allogeneic HCT in this setting is currently unclear. In addition, allogeneic HCT may also be considered for relatively fit adult B-cell ALL patients with high-risk cytogenetic features (ie, hypodiploidy, complex karyotype, *MLL* rearrangements).

The effect of WBC counts on prognosis in adult patients with ALL is less firmly established than in pediatric populations. For adult patients experiencing less than a CR after initial induction therapy, the treatment approach would be similar to that for patients with relapsed/refractory ALL (as discussed below).

For patients who are less fit (age ≥65 years or patients with substantial comorbidities), the recommended induction therapy includes multiagent chemotherapy regimens or corticosteroids. Dose modifications may be required for chemotherapy agents, as needed. Patients with a CR to induction should continue consolidation with chemotherapy regimens;

maintenance therapy (typically weekly methotrexate, daily 6-MP, and monthly pulses of vincristine/prednisone for 2–3 years) is recommended. For patients with less than a CR to induction, the treatment option would be similar to that for patients with relapsed/refractory ALL.

For patients with relapsed/refractory disease after an initial CR, participation in a clinical trial is preferred, when possible. In the absence of an appropriate trial, patients may be considered for second-line therapy with induction regimens not previously used, subsequent chemotherapy (with regimens containing clofarabine [for B-ALL], nelarabine [for T-cell ALL], VSLI, cytarabine, or alkylating agents), or allogeneic HCT in those physically fit enough to undergo transplantation. For patients with Ph-negative precursor B-cell ALL, blinatumomab is a preferred option.

For recommendations on the treatment of adult patients with mature B-cell ALL, refer to the [NCCN Guidelines for NHL: Burkitt Lymphoma](#).

Management of Lymphoblastic Lymphoma

As previously discussed, patients with lymphoblastic lymphoma generally benefit from treatment with ALL-like regimens and should be treated in a center that has experience with lymphoblastic lymphoma. Chemotherapy should be initiated as soon as possible; combination chemotherapy has shown improved response though relapse is common.²⁷⁰ In patients with lymphoblastic lymphoma, a 5-year DFS rate between 60% and 80% in children and between 55% and 95% in adults was seen following a regimen of cyclophosphamide, doxorubicin, vincristine, and prednisone (CHOP) or other CHOP-like regimens.^{271,272} Hyper-CVAD (cycles of fractionated cyclophosphamide, vincristine, doxorubicin, and dexamethasone alternating with cycles of high-dose methotrexate and cytarabine) is also a common regimen used for

lymphoblastic lymphoma. A response rate of 100% was seen in a singular study, with 91% of patients achieving a CR and a 3-year progression-free survival (PFS) of 66%.²⁷³ However, it should be noted that 40% to 60% of adults relapse, suggesting that other treatments including HCT may be warranted.

Evaluation and Treatment of Extramedullary Disease

CNS Involvement in ALL

Although the presence of CNS involvement at diagnosis is uncommon (approximately 3%–7% of cases), a substantial proportion of patients (>50%) will eventually develop CNS leukemia in the absence of CNS-directed therapy.^{1,38} CNS leukemia is defined by a WBC count of 5 leukocytes/mcL or greater in the CSF with the presence of lymphoblasts.^{1,38} In children with ALL, CNS leukemia at diagnosis was associated with significantly decreased EFS rates.^{88,274,275} Factors associated with an increased risk for CNS leukemia in children include T-cell immunophenotype, high WBC counts at presentation, Ph-positive disease, t(4;11) translocation, and presence of leukemic cells in the CSF.⁹⁴ In adults with ALL, CNS leukemia at diagnosis has been associated with a significantly higher risk for CNS relapse in large trials, although no differences were observed in 5-year EFS or DFS rates compared with subgroups without CNS leukemia at presentation.^{276,277} CNS leukemia at diagnosis was associated with a significantly decreased 5-year OS rate in one trial (29% vs. 38%; $P = .03$)²⁷⁶ but not in another trial (35% vs. 31%).²⁷⁷ Factors associated with an increased risk for CNS leukemia in adults include mature B-cell immunophenotype, T-cell immunophenotype, high WBC counts at presentation, and elevated serum LDH levels.^{31,276} CNS-directed therapy may include cranial irradiation, intrathecal chemotherapy (eg, methotrexate, cytarabine, corticosteroids), and/or high-dose systemic

chemotherapy (eg, methotrexate, cytarabine, 6-MP, L-asparaginase).^{1,38,94}

Although cranial irradiation is an effective treatment modality for CNS leukemia, it can be associated with serious adverse events, such as neurocognitive dysfunctions, secondary malignancies, and other long-term complications.^{1,94} With the increasing use of effective intrathecal chemotherapy and high-dose systemic chemotherapy regimens, studies have examined the feasibility of eliminating cranial irradiation as part of CNS prophylaxis. In studies of children with ALL who only received intrathecal and/or intensive systemic chemotherapy for CNS prophylaxis, the 5-year cumulative incidence of isolated CNS relapse or any CNS relapse was 3% to 4% and 4% to 5%, respectively.^{86,275}

Data from the most recent Total Therapy (XV) study by the St. Jude Children's Research Hospital showed dramatic improvements in survival outcomes for the AYA population. In this study, patients were primarily risk-stratified based on treatment response; patients were treated according to risk-adjusted intensive chemotherapy, with the incorporation of MRD evaluation during induction (day 19) to determine the need for additional doses of asparaginase.^{275,278} The 5-year EFS rate for the AYA population (age 15–18 years; $n = 45$) was 86% (95% CI, 72%–94%), which was not significantly different from the 87% EFS rate (95% CI, 84%–90%; $P = .61$) observed for the younger patients ($n = 448$). The 5-year OS rates for the AYA patients and younger patients were 88% and 94%, respectively ($P =$ not significant).^{275,278} The favorable EFS and OS outcomes in AYA patients in this study were attributed partly to the use of intensive dexamethasone, vincristine, and asparaginase, in addition to early intrathecal therapy (ie, triple intrathecal chemotherapy with cytarabine, hydrocortisone, and methotrexate) for CNS-directed therapy. In addition, the use of prophylactic cranial irradiation was safely omitted in this study; the 5-

year cumulative incidence of isolated CNS relapse and any CNS relapse was 3% and 4%, respectively, for the entire study population (n = 498).²⁷⁵ Moreover, all 11 patients with isolated CNS relapse were children younger than 12 years of age. This study showed that, with intensive risk-adjusted therapy and effective CNS-directed intrathecal regimens, AYA patients can obtain long-term EFS without the need for cranial irradiation or routine allogeneic HCT.^{275,278}

In adult patients with ALL who only received intrathecal chemotherapy and intensive systemic chemotherapy for CNS prophylaxis, the overall CNS relapse rate was 2% to 6%.^{96,97,279,280} Therefore, with the incorporation of adequate systemic chemotherapy (eg, high-dose methotrexate and cytarabine) and intrathecal chemotherapy regimens (eg, methotrexate alone or with cytarabine and corticosteroid, which constitutes the triple intrathecal regimen), the use of upfront cranial irradiation can be avoided except in cases of overt CNS leukemia at presentation, and the use of irradiation can be reserved for advanced disease. CNS prophylaxis is typically given throughout the course of ALL therapy starting from induction, to consolidation, to the maintenance phases of treatment.

NCCN Recommendations for Evaluation and Treatment of Extramedullary Involvement

Given the risks of neurologic adverse events associated with CNS-directed therapy, comprehensive neuropsychologic testing may be useful at baseline and during posttreatment follow-up. CNS involvement should be evaluated with lumbar puncture at timing in accordance to the specific treatment protocol used for each patient. Pediatric-inspired treatment regimens typically include lumbar puncture at diagnostic workup. The panel recommends that lumbar puncture, if performed, be conducted concomitantly with initial intrathecal therapy. All patients being treated for ALL should receive adequate CNS prophylaxis with

intrathecal therapy and/or systemic therapy that incorporates methotrexate.

The classification of CNS status includes the following: CNS-1 refers to no lymphoblasts in the CSF regardless of WBC count; CNS-2 is defined as a WBC count less than 5 leukocytes/mcL in the CSF with the presence of blasts; and CNS-3 is defined as a WBC count of 5 leukocytes/mcL or greater with the presence of blasts. If the patient has leukemic cells in the peripheral blood and the lumbar puncture is traumatic (containing ≥ 5 WBC/mcL in CSF with blasts), then the Steinherz-Bleyer algorithm can be used to determine the CNS classification (if the WBC/RBC ratio in the CSF is at least 2-fold greater than the WBC/RBC ratio in the blood, then the classification would be CNS-3; if not, the classification would be CNS-2).

In general, patients with CNS involvement at diagnosis (ie, CNS-3 and/or cranial nerve involvement) should receive 18 Gy of cranial irradiation. The entire brain and posterior half of the globe should be included. The inferior border should be below C2. Notably, areas of the brain targeted by the radiation field in the management of patients with ALL are different from those targeted for brain metastases of solid tumors. In addition, patients with CNS leukemia at diagnosis should receive adequate systemic therapy as well as intrathecal therapy containing methotrexate throughout the treatment course. Adequate systemic therapy should also be given in the management of patients with isolated CNS relapse.

A testicular examination should be performed for all male patients at diagnostic workup; testicular involvement is especially common among patients with T-cell ALL. Patients with clinical evidence of testicular disease at diagnosis that is not fully resolved by the end of induction therapy should be considered for radiation to the testes in the scrotal

sac. Radiation therapy is typically performed concurrently with the first cycle of maintenance chemotherapy. Testicular total dose should be 24 Gy.

Response Assessment and Surveillance

Response Criteria

Response in Bone Marrow and Peripheral Blood

A CR requires the absence of circulating blasts and absence of extramedullary disease (ie, no lymphadenopathy, splenomegaly, skin/gum infiltration, testicular mass, CNS involvement). A bone marrow assessment should show trilineage hematopoiesis and fewer than 5% blasts. For a CR, absolute neutrophil counts (ANCs) should be greater than $1.0 \times 10^9/L$ and platelet counts should be greater than $100 \times 10^9/L$. In addition, no recurrence should be observed for at least 4 weeks. A patient is considered to have a CRi if criteria for CR are met except the ANC remains less than $1.0 \times 10^9/L$ or the platelet count remains less than $100 \times 10^9/L$.

Refractory disease is defined as failure to achieve a CR at the end of induction therapy. PD is defined as an increase in the absolute number of circulating blasts (in peripheral blood) or bone marrow blasts by at least 25%, or the development of extramedullary disease. Relapsed disease is defined as the reappearance of blasts in the blood or bone marrow (>5%) or in any extramedullary site after achievement of a CR.

Response in CNS Disease

Remission of CNS disease is defined as achievement of CNS-1 status (no lymphoblasts in CSF regardless of WBC count) in a patient with CNS-2 or CNS-3 at diagnosis. CNS relapse is defined as development of CNS-3 status or development of clinical signs of CNS leukemia (eg, facial nerve palsy, brain/eye involvement, hypothalamic syndrome).

Response in Mediastinal Disease

To assess treatment response, a CT of the chest with IV contrast and PET imaging should be performed. A CR of mediastinal disease is defined as complete resolution of mediastinal enlargement by CT scan. For patients with a previous positive PET scan, a post-treatment residual mass of any size is considered a CR if it is PET negative. A partial response (PR) is defined as a greater than 50% decrease in the sum product of the greatest perpendicular diameters (SPD) of mediastinal enlargement. PD is defined as a greater than 25% increase in the SPD. No response indicates failure to meet the criteria for a PR and absence of PD (as defined earlier). Relapsed mediastinal disease is defined as recurrence of mediastinal enlargement after achievement of a CR. In cases of PR, PD, or relapse, for patients with a previous positive PET scan, the post-treatment PET must be positive in at least one previously involved site.

Surveillance

After completion of the ALL treatment regimen (including maintenance therapy), the panel recommends surveillance at regular intervals to assess disease status. During the first year after completion of therapy, patients should undergo a complete physical examination and blood tests (CBC with differential) on a monthly basis. Liver function tests should be performed every 2 months until normal values are achieved. Assessment of bone marrow aspirate, CSF, and an echocardiogram should be performed as clinically indicated; if a bone marrow aspirate is performed, flow cytometry with additional studies that may include comprehensive cytogenetics, FISH, and molecular tests should be carried out. During the second year after completion of therapy, a physical examination (including a testicular examination, where applicable) and blood tests (CBC with differential) should be performed every 3 months. During the third year (and beyond) after completion of

therapy, physical examination (including a testicular examination, where applicable) and blood tests (CBC with differential) can be performed every 6 months or as clinically indicated.

The COG has published guidelines on long-term survivorship issues for survivors of childhood cancers.²⁸¹ These guidelines serve as a resource for clinicians and family members/caretakers, and have the goal of providing screening and management recommendations for late effects (those that may impact growth, cognitive function, emotional concerns, reproductive health, risks for secondary malignancies, and other important health issues) that may arise during the lifetime of an AYA cancer survivor as a result of the therapeutic agents used during the course of antitumor treatment.

Role of MRD Evaluation

MRD in ALL refers to the presence of leukemic cells below the threshold of detection using conventional morphologic methods. Patients who experienced a CR according to morphologic assessment alone can potentially harbor a large number of leukemic cells in the bone marrow: up to 10^{10} malignant cells.^{28,282}

The most frequently used methods for MRD assessment include multicolor flow cytometry to detect abnormal immunophenotypes and PCR assays to detect clonal rearrangements in immunoglobulin heavy chain genes and/or T-cell receptor genes. Current flow cytometry or PCR methods can detect leukemic cells at a sensitivity threshold of fewer than 1×10^{-4} (<0.01%) bone marrow mononuclear cells (MNCs). The concordance rate for detecting MRD between these methods is high. In a study that analyzed MRD using both flow cytometry and PCR techniques in 1375 samples from 227 patients with ALL, the concordance rate for MRD assessment (based on a detection threshold of $<1 \times 10^{-4}$ for both methods) was 97%.²⁸³ The combined or tandem

use of both methods would allow for MRD monitoring in all patients, thereby avoiding potential false-negative results.^{283,284} Numerous studies in both childhood and adult ALL have shown the prognostic importance of postinduction (and/or post-consolidation) MRD measurements in predicting the likelihood of disease relapse. New multiplexed PCR and next-generation sequencing for MRD are emerging methodologies. Currently these techniques may be labor- and resource-intensive for routine application in the clinical practice setting.

MRD Assessment in Childhood ALL

Among children with ALL who achieve a CR according to morphologic evaluation after induction therapy, approximately 25% to 50% may still have detectable MRD based on sensitive assays (in which the threshold of MRD negativity is $<1 \times 10^{-4}$ bone marrow MNCs).^{285,286} An early study in children with ALL ($n = 178$) showed that patients with detectable MRD after initial induction therapy (42% of patients) had significantly shorter time to relapse than patients with MRD-negative status ($P < .001$), defined by a PCR sensitivity level of less than 1.5×10^{-4} .²⁸⁷ Patients with MRD after induction had a 10-fold increase in risk of death compared with those without detectable MRD. Moreover, the level of detectable MRD was found to correlate with relapse; patients with MRD of 1×10^{-2} or greater had a 16-fold higher risk of relapse compared with those who had MRD levels less than 1×10^{-3} .²⁸⁷ In another study in children with ALL ($n = 158$), patients with detectable MRD (flow cytometry sensitivity level $<1 \times 10^{-4}$) at the end of induction therapy had a significantly higher 3-year cumulative incidence of relapse than those who were MRD negative (33% vs. 7.5%; $P < .001$).²⁸⁸ Subsequent studies have confirmed these findings. In a study of 165 patients, the 5-year relapse rate was significantly higher among patients with MRD (flow cytometry sensitivity $<1 \times 10^{-4}$) versus those without detectable disease (43% vs. 10%; $P < .001$).²⁸⁶ Persistence of MRD during the

course of therapy was associated with risk of relapse; the cumulative rate of relapse was significantly higher among patients with MRD persisting through week 14 of continued treatment compared with patients who became MRD-negative by 14 weeks (68% vs. 7%; $P = .035$).²⁸⁶ MRD evaluation was shown to be a significant independent predictor of outcome.

MRD assessments at an earlier time point in the course of treatment (eg, during induction therapy) have been shown to be highly predictive of outcomes in children with ALL. In one study, nearly 50% of patients had MRD clearance (MRD $<1 \times 10^{-4}$ by flow cytometry) before day 19 of induction therapy (about 2–3 weeks from initiation of induction); the 5-year cumulative incidence of relapse was significantly higher among patients with MRD at day 19 of treatment than those without detectable MRD (33% vs. 6%; $P < .001$).²⁸⁵ The prognostic significance of MRD detection at lower levels (sensitivity threshold, $\leq 1 \times 10^{-5}$, or $\leq 0.001\%$, according to PCR measurements) was evaluated in children with B-cell lineage ALL treated with contemporary regimens.²⁸⁹ At the end of induction therapy, 58% of patients had undetectable disease based on PCR values. Among the remaining patients with detectable MRD, 17% had MRD of 0.01% or greater, 14% had less than 0.01% (but $\geq 0.001\%$), and 11% had less than 0.001%. The 5-year cumulative incidence of relapse was significantly higher among patients with MRD of 0.01% or greater versus patients with less than 0.01% or undetectable disease (23% vs. 6%; $P < .001$).²⁸⁹ Furthermore, the 5-year cumulative incidence of relapse was higher among the subgroup of patients with MRD less than 0.01% (but $\geq 0.001\%$) versus those with MRD less than 0.001% or undetectable disease (13% vs. 5%; $P < .05$). MRD status at the end of induction therapy strongly correlated with MRD levels (flow cytometry sensitivity level $<0.01\%$) at day 19 during induction; all patients who had MRD of 0.01% or greater at the end of induction had

MRD of 0.01% or greater at day 19. Although this study showed that a higher risk of relapse was seen among patients with MRD below the generally accepted threshold level ($<0.01\%$ but $\geq 0.001\%$) compared with those with very low MRD ($<0.001\%$) or no detectable disease, further studies are warranted to determine whether this threshold should be used to risk stratify patients or guide decisions surrounding treatment intensification.²⁸⁹

In one of the largest collaborative studies conducted in Europe (the AIEOP-BFM ALL 2000 study), children with Ph-negative B-cell lineage ALL ($n = 3184$ evaluable) were risk stratified according to MRD status (PCR sensitivity level $\leq 0.01\%$) at 2 time points (days 33 and 78), which were used to guide postinduction treatment.²⁹⁰ Patients were considered standard risk if MRD negativity ($\leq 0.01\%$) was achieved at both days 33 and 78, intermediate risk if MRD was greater than 0.01% (but $<0.1\%$) on either day 33 or 78 (the other time point being MRD-negative) or on both days 33 and 78, and high risk if MRD was 0.1% or greater on day 78. Nearly all patients with favorable cytogenetic/molecular markers such as the *ETV6-RUNX1* subtype or hyperdiploidy were either standard risk or intermediate risk based on MRD evaluation.²⁹⁰ The 5-year EFS rate was 92% for patients categorized as standard risk ($n = 1348$), 78% for intermediate risk ($n = 1647$), and 50% for high risk ($n = 189$) resulting in a statistically significant difference among the groups ($P < .001$); the 5-year OS rates were 98%, 93%, and 60%, respectively. MRD-based risk stratification significantly differentiated risks for relapse (between standard- and intermediate-risk subgroups) even among patient populations with *ETV6-RUNX1* or hyperdiploidy. Importantly, in this large-scale study, MRD remained a significant and powerful independent prognostic factor for relapse in the overall population.²⁹⁰

A randomized controlled trial in children and young adults with low-risk ALL according to MRD compared treatment reduction to standard induction (n = 521).²⁹¹ Patients were randomized to receive either one or two delayed intensification courses consisting of pegaspargase on day 4; vincristine, dexamethasone (alternate weeks), and doxorubicin for 3 weeks; and 4 weeks of cyclophosphamide and cytarabine. The 5-year EFS between the two cohorts was not statistically significant (94.4% vs. 95.5%; OR, 1; 95% CI, 0.43–2.31; two-sided $P = .99$). No statistical difference was seen regarding relapse or serious adverse events; however, there was a singular treatment-related death in the second delayed intensification cohort and 74 episodes of grade 3 or 4 toxic events. The results suggest that treatment reduction is reasonable for children and young adults with ALL who have a low risk of relapse based on MRD at the end of induction.

A recent randomized study investigated whether improved outcome could be seen with augmented post-remission therapy for children and young adults stratified by MRD.²⁹² In this trial, 533 patients with a high risk of MRD (defined as clinical standard-risk and intermediate-risk patients with MRD of 0.01% or higher at day 29 of induction) were randomized to receive standard therapy or augmented post-remission therapy. The augmented treatment regimen included eight doses of pegaspargase, 18 doses of vincristine, and escalated dosing of intravenous methotrexate without folinic acid rescue during the interim maintenance courses. The 5-year EFS was higher in patients receiving the augmented regimen versus the standard treatment group (89.6% vs. 82.8%; OR, 0.61; 95% CI, 0.39–0.98; $P = .04$). However, it should be noted that more adverse events were seen with the augmented regimen, and no statistically significant benefit was seen in OS at 5 years (92.9% vs. 88.9%; OR, 0.67; 95% CI, 0.38–1.17; $P = .16$).

Stratification based on MRD may also indicate which patients should undergo allogeneic HCT versus continued chemotherapy. Children with an intermediate risk of relapse based on MRD were stratified based on a cutoff MRD level of 10^{-3} .²⁹³ Patients with greater than or equal to MRD of 10^{-3} were allocated to receive HCT (n = 99). In this group, 83% had donors and underwent HCT versus 17% who had no suitable donor and therefore continued chemotherapy. The EFS was higher for patients receiving HCT (64% ± 5%) versus patients remaining on chemotherapy (24% ± 10%). Patients who had a low level of MRD (less than 10^{-3}) were directed to receive continued chemotherapy (n = 109). Within this cohort, 83 patients received either chemotherapy or radiotherapy alone and 22 patients received an allogeneic HCT. There was no significant difference in EFS between these two groups (66% ± 6% vs. 80% ± 9%; $P = .45$). Results indicate that MRD can be useful to further risk stratify patients with intermediate risk of relapse to the appropriate treatment regimen. However, the study acknowledges that MRD cutoff values are regimen dependent as indicated by the divergence from the earlier ALL R3 trial. While the earlier trial advocated for the use of MRD to stratify patients for HCT, a higher threshold for MRD level was used (10^{-4}), a difference that may reflect the more intensive induction regimen.²⁹⁴ Therefore, MRD levels may influence treatment decisions, but the application of this prognostic factor must be carefully evaluated on a regimen-by-regimen basis.

Approximately 20% of children treated with intensive therapies for ALL will ultimately experience disease relapse.²⁹⁵ MRD assessment may play a prognostic role in the management of patients in the relapsed setting.^{296,297} In patients (n = 35) who experienced a second remission (morphologic CR) after reinduction treatment, MRD (measured by flow cytometry with sensitivity level <0.01%) after reinduction (day 36) was significantly associated with risks for relapse; the 2-year cumulative

incidence of relapse was 70% among patients with MRD of 0.01% or greater versus 28% among those with MRD less than 0.01% ($P = .008$).²⁹⁶ In addition, in the subgroup of patients who experienced first relapse after cessation of treatment, the 2-year cumulative incidence of second relapse was 49% in patients with MRD of 0.01% or greater versus 0% for those with MRD less than 0.01% ($P = .014$). Both the presence of MRD at day 36 of reinduction therapy and at first relapse occurring during therapy were significant independent predictors of second relapse based on multivariate analysis.²⁹⁶ In another study, MRD (PCR sensitivity level <0.01%) was evaluated in high-risk children with ALL ($n = 60$) who experienced first relapse within 30 months from the time of diagnosis.²⁹⁷ Categories based on MRD evaluation after the first chemotherapy cycle (3–5 weeks after initiation of reinduction treatment) included MRD negative (undetectable MRD), MRD positive but unquantifiable (levels <0.01%), and MRD of 0.01% or greater. The 3-year EFS rates based on these MRD categories were 73%, 45%, and 19%, respectively ($P < .05$).²⁹⁷ Thus, MRD assessment can identify patients with a high probability of second relapse, which may offer an opportunity for risk-adapted second-line treatment strategies.

Several studies suggest early assessment of MRD during induction treatment (eg, day 15 from initiation of treatment) may be highly predictive of subsequent relapse in children with ALL.^{298,299} This raises the possibility of identifying patients with high-risk disease who may potentially benefit from earlier intensification or tailoring of treatment regimens, or for potentially allowing less-intensive treatments to be administered in patients at low risk for relapse based on early MRD measurements. Large trials are warranted to address these possibilities, although serial MRD measurements may likely be needed to monitor leukemic cell kinetics during the long course of treatment.

MRD Assessment in Adult ALL

Studies in adults with ALL have shown the strong correlation between MRD and risk for relapse, and the prognostic significance of MRD measurements during and after initial induction therapy.^{282,300-303} In an analysis of postinduction MRD (flow cytometry sensitivity level <0.05%) in adult patients with ALL ($n = 87$), median RFS was significantly longer among patients with MRD less than 0.05% at day 35 compared with those with MRD of 0.05% or greater (42 vs. 16 months; $P = .001$).³⁰³ A similar pattern emerged when only the subgroup of patients with morphologic CR at day 35 was included in the MRD evaluation. Although patient numbers were limited, 90% of patients with MRD less than 0.03% at an earlier time point (day 14 during induction therapy) remained relapse-free at 5 years.³⁰³ MRD after induction therapy was a significant predictor of relapse in a subgroup analysis from the MRC UKALL/ECOG study of patients with Ph-negative B-cell lineage ALL ($n = 161$).³⁰² The 5-year RFS rate was significantly higher in patients with MRD negativity versus those with MRD of 0.01% or greater (71% vs. 15%; $P = .0002$).³⁰²

Postinduction MRD can serve as an independent predictor of relapse even among adult patients considered to be standard risk based on traditional prognostic factors. In a study of adult patients with Ph-negative ALL ($n = 116$), MRD status after induction therapy (flow cytometry sensitivity level <0.1%) was significantly predictive of relapse regardless of whether the patient was standard risk or high risk at initial evaluation.³⁰¹ Among patients who were initially classified as standard risk, those with MRD of less than 0.1% after induction had a significantly lower risk of relapse at 3 years compared with patients who had higher levels of MRD (9% vs. 71%; $P = .001$). Interestingly, MRD measured during the post-consolidation time point was not significantly predictive of outcomes.³⁰¹ In the German Multicenter ALL (GMALL) 06/99 study,

patients with standard-risk disease ($n = 148$ evaluable) were monitored for MRD (PCR sensitivity level $<0.01\%$) at various time points during the first year of treatment.³⁰⁰ Only patients with ALL who met all of the following criteria for standard risk were enrolled in this study: absence of $t(4;11)$ *MLL* translocation or $t(9;22)$ *BCR-ABL* translocation; WBC count less than $30 \times 10^9/L$ for B-cell lineage ALL or less than $100 \times 10^9/L$ for T-cell lineage ALL; age 15 to 65 years; and achievement of morphologic CR after phase I of induction treatment. At the end of initial induction therapy (day 24), patients with MRD of 0.01% or greater had a 2.4-fold higher risk (95% CI, 1.3–4.2) of relapse than those with MRD of less than 0.01%.³⁰⁰ Moreover, this study identified distinct risk groups according to MRD status at various time points. Patients categorized as low risk (10% of study patients) had MRD of less than 0.01% on days 11 and 24 (during and after initial induction), and had 3-year DFS and OS rates of 100% (for both endpoints). Patients in the high-risk group (23%) had MRD of 0.01% or greater persisting through week 16, and 3-year DFS and OS rates of 6% and 45%, respectively. All other patients (67%) categorized as intermediate risk had 3-year DFS and OS rates of 53% and 70%, respectively.³⁰⁰ Importantly, MRD was the only independently significant predictor of outcome in a multivariate Cox regression analysis that included gender, age, WBC count, B- or T-cell lineage, and MRD.

A recent prospective study (Japan ALL MRD2002) evaluated outcomes by MRD status in adult patients with Ph-negative ALL.³⁰⁴ Among the patients who achieved a CR after induction/consolidation ($n = 39$), those who were MRD negative ($<0.1\%$) after induction had a significantly higher 3-year DFS (69% vs. 31%; $P = .004$) compared with patients who were MRD positive; 3-year OS was higher among patients with MRD-negative status after induction, although the difference was not statistically significant (85% vs. 59%). Based on multivariate Cox

regression analysis, older age (>35 years) and MRD positivity after induction were significant independent factors predictive of decreased DFS. WBC counts and MRD status after consolidation were not significant predictors of DFS outcomes.³⁰⁴ Thus, MRD evaluation postinduction may provide additional risk stratification criteria among patients who would otherwise be considered standard risk according to evaluation of traditional prognostic factors.

MRD assessment after consolidation therapy has been shown to have prognostic significance, offering the possibility to adjust post-consolidation treatment approaches. In a study that evaluated MRD (PCR sensitivity level $<0.01\%$) after consolidation therapy (weeks 16–22 from initiation of induction) in adult patients with ALL ($n = 142$), patients with MRD of less than 0.01% ($n = 58$) were primarily allotted to receive maintenance chemotherapy for 2 years, whereas those with MRD of 0.01% or greater ($n = 54$) were eligible to undergo allogeneic HCT after high-dose therapy.³⁰⁵ The 5-year DFS rate was significantly higher among patients with MRD negativity versus those with MRD of 0.01% or greater (72% vs. 14%; $P = .001$). Similarly, the 5-year OS rate was significantly higher for patients with MRD-negative status post-consolidation (75% vs. 33%; $P = .001$).³⁰⁵ In a follow-up to the GMALL 06/99 study mentioned earlier, patients with standard-risk ALL (as defined by Bruggemann et al³⁰⁰) who experienced MRD negativity (PCR sensitivity $<0.01\%$ leukemic cells) during the first year of treatment underwent sequential MRD monitoring during maintenance therapy and follow-up.³⁰⁶ Among the patients included in this analysis ($n = 105$), 28 (27%) became MRD-positive after the first year of therapy; MRD was detected before hematologic relapse in 17 of these patients.³⁰⁶ The median RFS was 18 months (calculated from the end of initial treatment) among the subgroup that became MRD-positive, whereas the median RFS has not yet been reached among patients who

remained MRD-negative. The median time from MRD positivity (at any level, including non-quantifiable cases) to clinical relapse was 9.5 months; the median time from quantitative MRD detection to clinical relapse was only 4 months.³⁰⁶ Detection of post-consolidation MRD was highly predictive of subsequent hematologic relapse and introduced the concept of molecular relapse in ALL.

GMALL investigators evaluated the potential advantage of intensifying or modifying treatment regimens (eg, incorporation of allogeneic HCT) based on post-consolidation MRD status. In one of the largest studies to assess the prognostic impact of MRD on treatment outcomes in adult patients with Ph-negative ALL (n = 580 with CR and evaluable MRD results; patients from GMALL 06/99 and 07/03 studies; age 15–55 years), molecular CR (defined as MRD <0.01%) after consolidation was associated with significantly higher probabilities of 5-year continuous CR (74% vs. 35%; $P < .0001$) and OS (80% vs. 42%; $P = .0001$) compared with molecular failure (MRD $\geq 0.01\%$).³⁰⁷ Based on multivariate analysis, molecular response status was a significant independent predictor of both 5-year continuous CR and OS outcomes. Among the patients with disease that did not result in a molecular CR, the subgroup who underwent allogeneic HCT in clinical CR (n = 57) showed a significantly higher 5-year continuous CR (66% vs. 12%; $P < .0001$) and a trend for higher OS (54% vs. 33%; $P = .06$) compared with the subgroup without HCT (n = 63).³⁰⁷ In this latter subgroup of patients with disease that did not result in a molecular CR and who did not undergo HCT, the median time from MRD detection to clinical relapse was approximately 8 months.³⁰⁷ This analysis showed that MRD status following consolidation was an independent risk factor for poorer outcomes in adults with ALL, and may identify high-risk patients who could potentially benefit from allogeneic HCT.

Studies in children and adult patients with ALL suggest that differences may exist in the kinetics of leukemic cell eradication between these patient populations. Among children treated on contemporary regimens, 60% to 75% experienced clearance of MRD at the end of induction therapy (typically 5–6 weeks after initiation of induction).^{285-289,308} In one study, nearly 50% of children had MRD clearance (<0.01% by flow cytometry) at day 19 of induction therapy.²⁸⁵ Adult patients seem to have a slower rate of leukemic cell clearance compared with children, with 30% to 50% of adult patients having MRD negativity after initial induction.^{300,303} Approximately 50% of cases remained MRD positive at 2 months after initiation of induction, with further reductions in the proportion of MRD-positive cases occurring beyond 3 to 5 months.^{282,300} Possible determinants for differences in the kinetics of leukemic cell reduction in the bone marrow may be attributed to the therapeutic regimens, variations in the distribution of immunophenotypic or cytogenetic/molecular features, and other host factors.

NCCN Recommendations for MRD Assessment

Collectively, studies show the high prognostic value of MRD in assessing risk for relapse in patients with ALL, and the role of MRD monitoring in identifying subgroups of patients who may benefit from further intensified therapies or alternative treatment strategies. Multicolor flow cytometry or PCR methods can detect leukemic cells at a sensitivity threshold of fewer than 1×10^{-4} (<0.01%) bone marrow MNCs.^{309,310} The concordance rate for detecting MRD between these methods is high, and combined or tandem use of both methods allows for MRD monitoring in all patients, thus avoiding potential false-negative results.³⁰⁹

The timing of MRD assessment varies depending on the ALL treatment protocol used, and may occur during or after completion of initial

induction therapy. Therefore, it is recommended that the initial measurement be performed on completion of induction therapy; additional time points for MRD evaluation may be useful depending on the treatment protocol or regimen used.^{309,310}

Supportive Care for Patients with ALL

Given the highly complex and intensive treatment protocols used in the management of ALL, supportive care issues are important considerations to ensure that patients derive the most benefit from ALL therapy. Although differences may exist between institutional standards and practices, supportive care measures for patients with ALL generally include the use of antiemetics for prevention of nausea and vomiting, blood product transfusions or cytokine support for severe cytopenias, nutritional support for prevention of weight loss, gastroenterology support, pain management, prevention and management of infectious complications, and prophylaxis for TLS. In addition, both short- and long-term consequences of potential toxicities associated with specific agents used in ALL regimens should be considered, such as with steroids (eg, risks for hyperglycemia or peptic ulcerations in the acute setting; risks for osteonecrosis or avascular necrosis with long-term use) and asparaginase (eg, risks for hypersensitivity reactions, hyperglycemia, coagulopathy, hepatotoxicity, and/or pancreatitis). Supportive care measures should be tailored to meet the individual needs of each patient based on factors such as age, performance status, extent of cytopenias before and during therapy, risks for infectious complications, disease status, and the specific agents used in the ALL treatment regimen.

NCCN Recommendations for Supportive Care

Most chemotherapy regimens used in ALL contain agents that are at least moderately emetogenic, which may necessitate antiemetic support

before initiating emetogenic chemotherapy. Antiemesis prophylaxis may include the use of agents such as serotonin receptor antagonists, corticosteroids, and/or neurokinin-1–receptor antagonists. Recommendations for antiemetic support for patients receiving chemotherapy are available in the [NCCN Guidelines for Antiemesis](#). For patients with ALL, the routine use of corticosteroids as part of antiemetic therapy should be avoided given that steroids constitute a major component of ALL regimens. For patients experiencing greater than 10% weight loss, enteral or parenteral nutritional support should be considered. Regimens to maintain bowel movement and prevent the occurrence of constipation may need to be considered for some patients.

For patients requiring transfusion support for severe or prolonged cytopenias, only irradiated blood products should be used. Growth factor support is recommended during blocks of myelosuppressive therapy or as directed by the treatment protocol being followed for individual patients (see [NCCN Guidelines for Myeloid Growth Factors](#)).

Patients with ALL undergoing intensive chemotherapy or allogeneic HCT are highly susceptible to infections. Immunosuppression caused by the underlying disease and therapeutic regimens can predispose patients to common bacterial and viral infections, and to various opportunistic infections (eg, candidiasis, invasive mold infections, *Pneumocystis jirovecii*, cytomegalovirus [CMV] reactivation and infection), particularly during periods of prolonged neutropenia. Patients with ALL should be closely monitored for any signs or symptoms of infections. Cases of febrile neutropenia should be managed promptly with empiric anti-infectives and inpatient admission. For recommendations for the prevention and management of infections in patients with cancer, see the [NCCN Guidelines for the Prevention and Treatment of Cancer-Related Infections](#). For patients with ALL,

antibacterial prophylaxis with fluoroquinolones should be considered in those with expected duration of neutropenia (ANC <1000/mcL) of more than 7 days. Antiviral prophylaxis is recommended in herpes simplex virus (HSV)–seropositive patients receiving induction/consolidation chemotherapy, during active therapy and periods of neutropenia. A longer period of prophylaxis may need to be considered in allogeneic HCT recipients with GVHD or with frequent HSV reactivations before transplantation. In addition, varicella zoster virus (VZV) prophylaxis during the 12-month period after allogeneic HCT may be recommended in patients who are VZV-seropositive pretransplant. Although higher doses are necessary, the same agents used as HSV prophylaxis are also active against VZV. For allogeneic HCT candidates who are seropositive for hepatitis B virus (HBV; hepatitis B surface antigen positive and/or hepatitis B core antibody positive), HBV prophylaxis should be considered starting shortly before the transplant procedure and surveillance should be continued until 6 to 12 months after HCT or during GVHD (see the [NCCN Guidelines for the Prevention and Treatment of Cancer-Related Infections](#)). Antifungal prophylaxis with fluconazole or micafungin (category 2A) should be considered for all patients with ALL treated with chemotherapy. If an amphotericin B product (category 2B) is used for antifungal prophylaxis, a lipid formulation is generally preferred because of less infusional and renal toxicity compared with conventional amphotericin B. Antifungal prophylaxis with posaconazole, itraconazole, and voriconazole should be avoided in patients receiving vinca alkaloids (eg, vincristine, which is included as a component of nearly all treatment regimens for ALL) because of the potential of these azoles to inhibit the cytochrome P450 3A4 isoenzyme, potentially reducing clearance of vinca alkaloids. Trimethoprim/sulfamethoxazole (TMP-SMX) for *P jirovecii* prophylaxis is effective in preventing *Pneumocystis* pneumonia in patients with acute leukemias,^{311,312} and should be considered a category 1

recommendation for all patients receiving chemotherapy for ALL. Clinicians should be aware of potential drug interactions when using TMP-SMX, as this agent can increase systemic exposure to methotrexate (due to decrease in renal clearance), thereby increasing the risks for myelotoxicity with methotrexate.^{313,314} High doses of methotrexate can result in toxic plasma methotrexate concentrations (>10 microM/L beyond 42–48 hours) in patients with delayed methotrexate clearance. While this is more commonly seen in osteosarcoma and soft tissue tumors due to the higher dose of methotrexate in treatment, the FDA has approved the use of glucarpidase as a rescue product in patients with ALL. Leucovorin should also be given as part of the treatment of methotrexate toxicity (see *Supportive Care* in the algorithm). CMV monitoring and preemptive anti-CMV therapy should be considered for all patients; in particular, for patients undergoing allogeneic HCT, routine CMV surveillance should typically occur for 1 to 6 months posttransplant and during chronic GVHD requiring immunosuppressive therapy. Preemptive therapy is continued at a minimum until a negative PCR (see the [NCCN Guidelines for the Prevention and Treatment of Cancer-Related Infections](#)). It is important to note that the local susceptibility and resistance patterns of pathogens must be considered in the choice of anti-infective agents used for the prevention or treatment of infections.

Patients with ALL may be at high risk for developing acute TLS, particularly those with highly elevated WBC counts before induction chemotherapy. TLS is characterized by metabolic abnormalities stemming from the sudden release of intracellular contents into the peripheral blood because of cellular disintegration induced by chemotherapy. If left untreated, TLS can result in profound metabolic changes leading to cardiac arrhythmias, seizures, loss of muscle control, acute renal failure, and even death. Recommendations for the

management of TLS are available in the *Tumor Lysis Syndrome* section of the [NCCN Guidelines for NHL](#). Standard prophylaxis for TLS includes hydration with diuresis, alkalinization of the urine, and treatment with allopurinol or rasburicase. Rasburicase should be considered as initial treatment in patients with rapidly increasing blast counts, high uric acid, or evidence of impaired renal function. Although relatively uncommon in patients with ALL, symptomatic hyperleukocytosis (leukostasis) constitutes a medical emergency and requires immediate treatment, as recommended in the [NCCN Guidelines for Acute Myeloid Leukemia](#). Leukostasis is characterized by highly elevated WBC count (usually $>100 \times 10^9/L$) and symptoms of decreased tissue perfusion that often affect respiratory and CNS function. Although leukapheresis is not typically recommended in the routine management of patients with high WBC counts, it can be considered with caution in cases of leukostasis that is unresponsive to other interventions.

Key components of the ALL treatment regimen, such as corticosteroids and asparaginase, are associated with unique toxicities that require close monitoring and management. Corticosteroids, such as prednisone and dexamethasone, constitute a core component of nearly every ALL induction regimen, and are frequently incorporated into consolidation and/or maintenance regimens. Acute side effects of steroids may include hyperglycemia and steroid-induced diabetes mellitus. Patients should be monitored for glucose control using the Insulin Sliding Scale (ISS) to minimize the risk of developing infectious complications. Another acute side effect of steroid therapy includes peptic ulceration and dyspeptic symptoms; the use of histamine-2 receptor antagonists or proton pump inhibitors is recommended during steroid therapy to reduce these risks. Although uncommon, the use of high-dose corticosteroids can be associated with mood alterations, psychosis, and other neuropsychiatric complications in patients with malignancies;³¹⁵⁻³¹⁸

dose reductions may be required in these situations. A potential long-term side effect associated with steroid therapy includes osteonecrosis/avascular necrosis. Osteonecrosis most often affects weight-bearing joints, such as the hip and/or knee, and seems to have a higher incidence among adolescents (presumably because of the period of skeletal growth) than younger children or adults.³¹⁹⁻³²⁴ In children and adolescents (aged 1–21 years) with ALL evaluated in large studies of the CCG, the cumulative incidence of symptomatic osteonecrosis increased with age, from approximately 1% in patients younger than 10 years, to 10% to 13.5% in patients between the ages of 10 and 15 years, to 18% to 20% in patients aged 16 years and older.^{320,321} In the Total XV study in children with ALL, symptomatic osteonecrosis occurred in 18% of patients, with most cases occurring within 1 year of treatment initiation.³¹⁹ Older children (aged >10 years) had a significantly higher cumulative incidence of osteonecrosis (45% vs. 10%; $P < .001$) compared with younger children (aged ≤ 10 years). In this study, factors such as older age, lower serum albumin levels, higher serum lipid levels, and higher exposure to dexamethasone were associated with risks for osteonecrosis. Moreover, higher plasma exposure to dexamethasone (as measured by area under the concentration curve at Week 8 of therapy) and lower serum albumin were significant factors associated with the development of severe (grade 3 or 4) osteonecrosis, even after adjusting for age and treatment arm.³¹⁹

In a recent DFCI ALL Consortium study in children and adolescents that included randomization to postinduction therapy with dexamethasone versus prednisone, dexamethasone was associated with a significantly increased 5-year EFS but, in older children, the increased cumulative incidence of osteonecrosis was comparable with prednisone.³²⁴ An earlier CCG study (CCG-1882) had reported a higher incidence of

symptomatic osteonecrosis among children randomized to receive an augmented ALL regimen with 2 courses of dexamethasone compared with those who received 1 course (23% vs. 16%; $P =$ not significant).³²¹ These studies appeared to suggest that dexamethasone, particularly in higher doses, may be associated with increased risks for osteonecrosis in older children and adolescents. To further investigate these findings, the CCG-1961 trial randomized patients ($n = 2056$; age 1–21 years) to postinduction intensification treatment with intermittent dose scheduling of dexamethasone (10 mg/m² daily on days 0–6 and days 14–20) versus continuous doses of dexamethasone (10 mg/m² daily on days 0–20).³²⁰ Among older children and adolescents (age ≥ 10 years) who had rapid response to induction, use of intermittent dexamethasone during the intensification phase was associated with significantly decreased incidence of osteonecrosis compared with the standard continuous dose of dexamethasone (9% vs. 17%; $P = .0005$). The difference was particularly pronounced among adolescent patients 16 years and older (11% vs. 37.5%, respectively; $P = .0003$). This randomized trial suggested that the use of intermittent (alternative week) dexamethasone during intensification phases may reduce the risks of osteonecrosis in adolescents.³²⁰ To monitor patients for risks of developing symptomatic osteonecrosis, routine measurements for vitamin D and calcium levels should be obtained, and periodic radiographic evaluation (using plain films or MRI) should be considered.

Asparaginase is also a core component of ALL regimens, most often given during induction and consolidation for Ph-negative disease. Three different formulations of the enzyme have been approved by the FDA: 1) native *Escherichia coli* (*E coli*)-derived asparaginase (*E coli* asparaginase); 2) asparaginase derived from *E coli* that has been modified with a covalent linkage to PEG (pegaspargase); and 3) asparaginase derived from a different Gram-negative bacteria *Erwinia*

chrysanthemi (*Erwinia* asparaginase). These formulations differ in their pharmacologic properties, and may also differ in terms of immunogenicity.³²⁵⁻³²⁷ Regardless of the formulation, asparaginase can be associated with potentially severe hypersensitivity reactions (including anaphylaxis) due to anti-asparaginase antibodies and lack of efficacy in some cases. Pegaspargase seems to be associated with a lower incidence of neutralizing antibodies compared with native asparaginase.³²⁸ However, cross-reactivity between neutralizing antibodies against native *E coli* asparaginase and pegaspargase has been reported.^{329,330} Moreover, a high anti-asparaginase antibody level after initial therapy with native *E coli* asparaginase was associated with decreased asparaginase activity during subsequent therapy with pegaspargase.³³¹ In contrast, no cross-reactivity between antibodies against native *E coli* asparaginase and *Erwinia* asparaginase was reported,^{329,330} and enzyme activity of *Erwinia* asparaginase was not affected by the presence of anti-*E coli* asparaginase antibodies.³³¹ A study from the DFCC ALL Consortium showed the feasibility and activity of using *Erwinia* asparaginase in pediatric and adolescent patients who developed hypersensitivity reactions to *E coli* asparaginase during frontline therapy. Importantly, treatment with *Erwinia* asparaginase did not negatively impact EFS outcomes in these patients.³³²

Native *E coli* asparaginase is no longer available; therefore, the NCCN panel recommends the use of pegaspargase in the treatment of patients with ALL. For patients who develop severe hypersensitivity reactions during treatment with pegaspargase, *Erwinia* asparaginase should be substituted (see *Supportive Care: Asparaginase Toxicity Management* in the algorithm). *Erwinia* asparaginase is currently approved by the FDA for patients with ALL who have developed hypersensitivity to *E coli*-derived asparaginase.³³³ If the patient experiences Grade 1 or Grade 2 reactions including rash, flushing, urticaria, and drug fever



NCCN Guidelines Version 1.2017

Acute Lymphoblastic Leukemia

≥38°C without bronchospasm, hypotension, edema, or need for parenteral intervention, the asparaginase that caused the reaction may be continued with consideration for anti-allergy premedication (such as hydrocortisone, diphenhydramine, and acetaminophen). If anti-allergy medication is used prior to pegaspargase or *Erwinia* asparaginase administration, consideration should be given to therapeutic drug monitoring using commercially available asparaginase activity assays, since premedication may mask the systemic allergic reactions that can indicate the development of neutralizing antibodies.³³⁴ However, if the patient experiences anaphylaxis or other allergic reactions of Grade 3 or 4 severity (CTCAE 4.03), permanent discontinuation of the causative asparaginase is warranted.

Asparaginase can be associated with various toxicities, including pancreatitis (ranging from asymptomatic cases with amylase or lipase elevation, to symptomatic cases with vomiting or severe abdominal pain), hepatotoxicity (eg, increased alanine or glutamine aminotransferase), and coagulopathy (eg, thrombosis, hemorrhage). Detailed recommendations for the management of asparaginase toxicity in AYA and adult patients were published,³²⁷ and have been incorporated into the NCCN Guidelines for ALL (see *Supportive Care: Asparaginase Toxicity Management* in the algorithm).

Pain management should be employed for patients with cancer, regardless of disease stage. For discussion of the central principles of pain assessment and management, see the [NCCN Guidelines for Cancer Pain](#).

Discussion
Update in
progress

References

- Jabbour EJ, Faderl S, Kantarjian HM. Adult acute lymphoblastic leukemia. *Mayo Clin Proc* 2005;80:1517-1527. Available at: <http://www.ncbi.nlm.nih.gov/pubmed/16295033>.
- National Cancer Institute. SEER cancer statistics review, 1975-2013: Leukemia, annual incidence rates (acute lymphocytic leukemia). 2016. Available at: http://seer.cancer.gov/csr/1975_2013/. Accessed September 29, 2016.
- Siegel RL, Miller KD, Jemal A. Cancer statistics, 2016. *CA Cancer J Clin* 2016;66:7-30. Available at: <http://www.ncbi.nlm.nih.gov/pubmed/26742998>.
- National Cancer Institute. SEER cancer statistics review, 1975-2013: Overview, median age at diagnosis. 2016. Available at: http://seer.cancer.gov/csr/1975_2013/. Accessed September 29, 2016.
- National Cancer Institute. SEER cancer statistics review, 1975-2013: Overview, age distribution of incidence cases by site. 2016. Available at: http://seer.cancer.gov/csr/1975_2013/. Accessed September 29, 2016.
- Esparza SD, Sakamoto KM. Topics in pediatric leukemia--acute lymphoblastic leukemia. *MedGenMed* 2005;7:23. Available at: <http://www.ncbi.nlm.nih.gov/pubmed/16369328>.
- Hasle H. Pattern of malignant disorders in individuals with Down's syndrome. *Lancet Oncol* 2001;2:429-436. Available at: <http://www.ncbi.nlm.nih.gov/pubmed/11905737>.
- Whitlock JA. Down syndrome and acute lymphoblastic leukaemia. *Br J Haematol* 2006;135:595-602. Available at: <http://www.ncbi.nlm.nih.gov/pubmed/17054672>.
- Stiller CA, Chessells JM, Fitchett M. Neurofibromatosis and childhood leukaemia/lymphoma: a population-based UKCCSG study. *Br J Cancer* 1994;70:969-972. Available at: <http://www.ncbi.nlm.nih.gov/pubmed/7947106>.
- Shaw MP, Eden OB, Grace E, Ellis PM. Acute lymphoblastic leukemia and Klinefelter's syndrome. *Pediatr Hematol Oncol* 1992;9:81-85. Available at: <http://www.ncbi.nlm.nih.gov/pubmed/1558779>.
- Gurgey A, Kara A, Tuncer M, et al. Acute lymphoblastic leukemia associated with Klinefelter syndrome. *Pediatr Hematol Oncol* 1994;11:227-229. Available at: <http://www.ncbi.nlm.nih.gov/pubmed/8204450>.
- Machatschek JN, Schrauder A, Helm F, et al. Acute lymphoblastic leukemia and Klinefelter syndrome in children: two cases and review of the literature. *Pediatr Hematol Oncol* 2004;21:621-626. Available at: <http://www.ncbi.nlm.nih.gov/pubmed/15626018>.
- Flatt T, Neville K, Lewing K, Dalal J. Successful treatment of fanconi anemia and T-cell acute lymphoblastic leukemia. *Case Rep Hematol* 2012;2012:396395. Available at: <http://www.ncbi.nlm.nih.gov/pubmed/22937327>.
- Yetgin S, Tuncer M, Guler E, et al. Acute lymphoblastic leukemia in Fanconi's anemia. *Am J Hematol* 1994;45:94. Available at: <http://www.ncbi.nlm.nih.gov/pubmed/8250016>.
- Strevens MJ, Lilleyman JS, Williams RB. Shwachman's syndrome and acute lymphoblastic leukaemia. *Br Med J* 1978;2:18. Available at: <http://www.ncbi.nlm.nih.gov/pubmed/277273>.
- Woods WG, Roloff JS, Lukens JN, Krivit W. The occurrence of leukemia in patients with the Shwachman syndrome. *J Pediatr* 1981;99:425-428. Available at: <http://www.ncbi.nlm.nih.gov/pubmed/7264801>.
- Passarge E. Bloom's syndrome: the German experience. *Ann Genet* 1991;34:179-197. Available at: <http://www.ncbi.nlm.nih.gov/pubmed/1809225>.

18. Taylor AM, Metcalfe JA, Thick J, Mak YF. Leukemia and lymphoma in ataxia telangiectasia. *Blood* 1996;87:423-438. Available at: <http://www.ncbi.nlm.nih.gov/pubmed/8555463>.
19. Ma H, Sun H, Sun X. Survival improvement by decade of patients aged 0-14 years with acute lymphoblastic leukemia: a SEER analysis. *Sci Rep* 2014;4:4227. Available at: <http://www.ncbi.nlm.nih.gov/pubmed/24572378>.
20. Kenderian SS, Al-Kali A, Gangat N, et al. Monosomal karyotype in Philadelphia chromosome-negative acute lymphoblastic leukemia. *Blood Cancer J* 2013;3:e122. Available at: <http://www.ncbi.nlm.nih.gov/pubmed/23832069>.
21. Pulte D, Jansen L, Gondos A, et al. Survival of adults with acute lymphoblastic leukemia in Germany and the United States. *PLoS One* 2014;9:e85554. Available at: <https://www.ncbi.nlm.nih.gov/pubmed/24475044>.
22. Stock W. Adolescents and young adults with acute lymphoblastic leukemia. *Hematology Am Soc Hematol Educ Program* 2010;2010:21-29. Available at: <http://www.ncbi.nlm.nih.gov/pubmed/21239766>.
23. U.S. National Library of Medicine-Key MEDLINE® Indicators. Available at: http://www.nlm.nih.gov/bsd/bsd_key.html. Accessed September 29, 2016.
24. Faderl S, O'Brien S, Pui CH, et al. Adult acute lymphoblastic leukemia: concepts and strategies. *Cancer* 2010;116:1165-1176. Available at: <http://www.ncbi.nlm.nih.gov/pubmed/20101737>.
25. Borowitz MJ, Chan JKC. B lymphoblastic leukaemia/lymphoma, not otherwise specified In: Swerdlow SH, Campo E, Harris NL, et al., eds. *WHO Classification of Tumours of Haematopoietic and Lymphoid Tissues* (ed 4th). Lyon: IARC; 2008:168-170.
26. Borowitz MJ, Chan JKC. T lymphoblastic leukaemia/lymphoma. In: Swerdlow SH, Campo E, Harris NL, et al., eds. *WHO Classification of Tumours of Haematopoietic and Lymphoid Tissues* (ed 4th). Lyon: IARC; 2008:176-178.
27. Borowitz MJ, Chan JKC. B lymphoblastic leukaemia/lymphoma with recurrent genetic abnormalities. In: Swerdlow SH, Campo E, Harris NL, et al., eds. *WHO Classification of Tumours of Haematopoietic and Lymphoid Tissues* (ed 4th). Lyon: IARC; 2008:171-175.
28. Bassan R, Hoelzer D. Modern therapy of acute lymphoblastic leukemia. *J Clin Oncol* 2011;29:532-543. Available at: <http://www.ncbi.nlm.nih.gov/pubmed/21220592>.
29. Pui CH, Relling MV, Downing JR. Acute lymphoblastic leukemia. *N Engl J Med* 2004;350:1535-1548. Available at: <http://www.ncbi.nlm.nih.gov/pubmed/15071128>.
30. Bassan R, Gatta G, Tondini C, Willemze R. Adult acute lymphoblastic leukaemia. *Crit Rev Oncol Hematol* 2004;50:223-261. Available at: <http://www.ncbi.nlm.nih.gov/pubmed/15182827>.
31. Gokbuget N, Hoelzer D. Treatment of adult acute lymphoblastic leukemia. *Hematology Am Soc Hematol Educ Program* 2006:133-141. Available at: <http://www.ncbi.nlm.nih.gov/pubmed/17124052>.
32. Thomas DA, O'Brien S, Jorgensen JL, et al. Prognostic significance of CD20 expression in adults with de novo precursor B-lineage acute lymphoblastic leukemia. *Blood* 2009;113:6330-6337. Available at: <http://www.ncbi.nlm.nih.gov/pubmed/18703706>.
33. Coustan-Smith E, Mullighan CG, Onciu M, et al. Early T-cell precursor leukaemia: a subtype of very high-risk acute lymphoblastic leukaemia. *Lancet Oncol* 2009;10:147-156. Available at: <http://www.ncbi.nlm.nih.gov/pubmed/19147408>.
34. Zhang J, Ding L, Holmfeldt L, et al. The genetic basis of early T-cell precursor acute lymphoblastic leukaemia. *Nature* 2012;481:157-163. Available at: <http://www.ncbi.nlm.nih.gov/pubmed/22237106>.

35. Schrauder A, Reiter A, Gadner H, et al. Superiority of allogeneic hematopoietic stem-cell transplantation compared with chemotherapy alone in high-risk childhood T-cell acute lymphoblastic leukemia: results from ALL-BFM 90 and 95. *J Clin Oncol* 2006;24:5742-5749. Available at: <http://www.ncbi.nlm.nih.gov/pubmed/17179108>.

36. Armstrong SA, Look AT. Molecular genetics of acute lymphoblastic leukemia. *J Clin Oncol* 2005;23:6306-6315. Available at: <http://www.ncbi.nlm.nih.gov/pubmed/16155013>.

37. Moorman AV, Chilton L, Wilkinson J, et al. A population-based cytogenetic study of adults with acute lymphoblastic leukemia. *Blood* 2010;115:206-214. Available at: <http://www.ncbi.nlm.nih.gov/pubmed/19897583>.

38. Seibel NL. Treatment of acute lymphoblastic leukemia in children and adolescents: peaks and pitfalls. *Hematology Am Soc Hematol Educ Program* 2008:374-380. Available at: <http://www.ncbi.nlm.nih.gov/pubmed/19074113>.

39. Burmeister T, Schwartz S, Bartram CR, et al. Patients' age and BCR-ABL frequency in adult B-precursor ALL: a retrospective analysis from the GMALL study group. *Blood* 2008;112:918-919. Available at: <http://www.ncbi.nlm.nih.gov/pubmed/18650471>.

40. Gleissner B, Gokbuget N, Bartram CR, et al. Leading prognostic relevance of the BCR-ABL translocation in adult acute B-lineage lymphoblastic leukemia: a prospective study of the German Multicenter Trial Group and confirmed polymerase chain reaction analysis. *Blood* 2002;99:1536-1543. Available at: <http://www.ncbi.nlm.nih.gov/pubmed/11861265>.

41. Pui C-H, Evans WE. Treatment of acute lymphoblastic leukemia. *N Engl J Med* 2006;354:166-178. Available at: <http://www.ncbi.nlm.nih.gov/pubmed/16407512>.

42. Arico M, Valsecchi MG, Camitta B, et al. Outcome of treatment in children with Philadelphia chromosome-positive acute lymphoblastic

leukemia. *N Engl J Med* 2000;342:998-1006. Available at: <http://www.ncbi.nlm.nih.gov/pubmed/10749961>.

43. Den Boer ML, van Slegtenhorst M, De Menezes RX, et al. A subtype of childhood acute lymphoblastic leukaemia with poor treatment outcome: a genome-wide classification study. *Lancet Oncol* 2009;10:125-134. Available at: <http://www.ncbi.nlm.nih.gov/pubmed/19138562>.

44. Mullighan CG, Su X, Zhang J, et al. Deletion of IKZF1 and prognosis in acute lymphoblastic leukemia. *N Engl J Med* 2009;360:470-480. Available at: <http://www.ncbi.nlm.nih.gov/pubmed/19129520>.

45. Roberts KG, Morin RD, Zhang J, et al. Genetic alterations activating kinase and cytokine receptor signaling in high-risk acute lymphoblastic leukemia. *Cancer Cell* 2012;22:153-166. Available at: <http://www.ncbi.nlm.nih.gov/pubmed/22897847>.

46. Roberts KG, Li Y, Payne-Turner D, et al. Targetable kinase-activating lesions in Ph-like acute lymphoblastic leukemia. *N Engl J Med* 2014;371:1005-1015. Available at: <http://www.ncbi.nlm.nih.gov/pubmed/25207766>.

47. Schultz KR, Pullen DJ, Sather HN, et al. Risk- and response-based classification of childhood B-precursor acute lymphoblastic leukemia: a combined analysis of prognostic markers from the Pediatric Oncology Group (POG) and Children's Cancer Group (CCG). *Blood* 2007;109:926-935. Available at: <http://www.ncbi.nlm.nih.gov/pubmed/17003380>.

48. Mullighan CG, Miller CB, Radtke I, et al. BCR-ABL1 lymphoblastic leukaemia is characterized by the deletion of Ikaros. *Nature* 2008;453:110-114. Available at: <http://www.ncbi.nlm.nih.gov/pubmed/18408710>.

49. Caye A, Beldjord K, Mass-Malo K, et al. Breakpoint-specific multiplex polymerase chain reaction allows the detection of IKZF1

intragenic deletions and minimal residual disease monitoring in B-cell precursor acute lymphoblastic leukemia. *Haematologica* 2013;98:597-601. Available at: <http://www.ncbi.nlm.nih.gov/pubmed/23065506>.

50. Dupuis A, Gaub MP, Legrain M, et al. Biclinal and biallelic deletions occur in 20% of B-ALL cases with IKZF1 mutations. *Leukemia* 2013;27:503-507. Available at: <http://www.ncbi.nlm.nih.gov/pubmed/22868967>.

51. Mi JQ, Wang X, Yao Y, et al. Newly diagnosed acute lymphoblastic leukemia in China (II): prognosis related to genetic abnormalities in a series of 1091 cases. *Leukemia* 2012;26:1507-1516. Available at: <http://www.ncbi.nlm.nih.gov/pubmed/22297722>.

52. Martinelli G, Iacobucci I, Storlazzi CT, et al. IKZF1 (Ikaros) deletions in BCR-ABL1-positive acute lymphoblastic leukemia are associated with short disease-free survival and high rate of cumulative incidence of relapse: a GIMEMA AL WP report. *J Clin Oncol* 2009;27:5202-5207. Available at: <http://www.ncbi.nlm.nih.gov/pubmed/19770381>.

53. Iacobucci I, Storlazzi CT, Cilloni D, et al. Identification and molecular characterization of recurrent genomic deletions on 7p12 in the IKZF1 gene in a large cohort of BCR-ABL1-positive acute lymphoblastic leukemia patients: on behalf of Gruppo Italiano Malattie Ematologiche dell'Adulto Acute Leukemia Working Party (GIMEMA AL WP). *Blood* 2009;114:2159-2167. Available at: <http://www.ncbi.nlm.nih.gov/pubmed/19589926>.

54. van der Veer A, Waanders E, Pieters R, et al. Independent prognostic value of BCR-ABL1-like signature and IKZF1 deletion, but not high CRLF2 expression, in children with B-cell precursor ALL. *Blood* 2013;122:2622-2629. Available at: <http://www.ncbi.nlm.nih.gov/pubmed/23974192>.

55. Boer JM, van der Veer A, Rizopoulos D, et al. Prognostic value of rare IKZF1 deletion in childhood B-cell precursor acute lymphoblastic leukemia: an international collaborative study. *Leukemia* 2016;30:32-38. Available at: <http://www.ncbi.nlm.nih.gov/pubmed/26202931>.

56. Smith M, Arthur D, Camitta B, et al. Uniform approach to risk classification and treatment assignment for children with acute lymphoblastic leukemia. *J Clin Oncol* 1996;14:18-24. Available at: <http://www.ncbi.nlm.nih.gov/pubmed/8558195>.

57. Gadner H, Masera G, Schrappe M, et al. The Eighth International Childhood Acute Lymphoblastic Leukemia Workshop ('Ponte di legno meeting') report: Vienna, Austria, April 27-28, 2005. *Leukemia* 2006;20:9-17. Available at: <http://www.ncbi.nlm.nih.gov/pubmed/16281070>.

58. Behm FG, Raimondi SC, Frestedt JL, et al. Rearrangement of the MLL gene confers a poor prognosis in childhood acute lymphoblastic leukemia, regardless of presenting age. *Blood* 1996;87:2870-2877. Available at: <http://www.ncbi.nlm.nih.gov/pubmed/8639906>.

59. Pui CH, Chessells JM, Camitta B, et al. Clinical heterogeneity in childhood acute lymphoblastic leukemia with 11q23 rearrangements. *Leukemia* 2003;17:700-706. Available at: <http://www.ncbi.nlm.nih.gov/pubmed/12682627>.

60. Donadieu J, Auclerc MF, Baruchel A, et al. Prognostic study of continuous variables (white blood cell count, peripheral blast cell count, haemoglobin level, platelet count and age) in childhood acute lymphoblastic leukaemia. Analysis Of a population of 1545 children treated by the French Acute Lymphoblastic Leukaemia Group (FRALLE). *Br J Cancer* 2000;83:1617-1622. Available at: <http://www.ncbi.nlm.nih.gov/pubmed/11104555>.

61. Romana SP, Mauchauffe M, Le Coniat M, et al. The t(12;21) of acute lymphoblastic leukemia results in a tel-AML1 gene fusion. *Blood* 1995;85:3662-3670. Available at: <http://www.ncbi.nlm.nih.gov/pubmed/7780150>.

62. Sutcliffe MJ, Shuster JJ, Sather HN, et al. High concordance from independent studies by the Children's Cancer Group (CCG) and Pediatric Oncology Group (POG) associating favorable prognosis with combined trisomies 4, 10, and 17 in children with NCI Standard-Risk B-



NCCN Guidelines Version 1.2017

Acute Lymphoblastic Leukemia

precursor Acute Lymphoblastic Leukemia: a Children's Oncology Group (COG) initiative. *Leukemia* 2005;19:734-740. Available at: <http://www.ncbi.nlm.nih.gov/pubmed/15789069>.

63. Boissel N, Auclerc M-F, Lheritier V, et al. Should adolescents with acute lymphoblastic leukemia be treated as old children or young adults? Comparison of the French FRALLE-93 and LALA-94 trials. *J Clin Oncol* 2003;21:774-780. Available at: <http://www.ncbi.nlm.nih.gov/pubmed/12610173>.

64. Ramanujachar R, Richards S, Hann I, et al. Adolescents with acute lymphoblastic leukaemia: outcome on UK national paediatric (ALL97) and adult (UKALLXII/E2993) trials. *Pediatr Blood Cancer* 2007;48:254-261. Available at: <http://www.ncbi.nlm.nih.gov/pubmed/16421910>.

65. Zhang MJ, Hoelzer D, Horowitz MM, et al. Long-term follow-up of adults with acute lymphoblastic leukemia in first remission treated with chemotherapy or bone marrow transplantation. The Acute Lymphoblastic Leukemia Working Committee. *Ann Intern Med* 1995;123:428-431. Available at: <http://www.ncbi.nlm.nih.gov/pubmed/7639442>.

66. Thomas X, Boiron J-M, Huguet F, et al. Outcome of treatment in adults with acute lymphoblastic leukemia: analysis of the LALA-94 trial. *J Clin Oncol* 2004;22:4075-4086. Available at: <http://www.ncbi.nlm.nih.gov/pubmed/15353542>.

67. Goldstone AH, Richards SM, Lazarus HM, et al. In adults with standard-risk acute lymphoblastic leukemia, the greatest benefit is achieved from a matched sibling allogeneic transplantation in first complete remission, and an autologous transplantation is less effective than conventional consolidation/maintenance chemotherapy in all patients: final results of the International ALL Trial (MRC UKALL XII/ECOG E2993). *Blood* 2008;111:1827-1833. Available at: <http://www.ncbi.nlm.nih.gov/pubmed/18048644>.

68. Vey N, Thomas X, Picard C, et al. Allogeneic stem cell transplantation improves the outcome of adults with t(1;19)/E2A-PBX1

and t(4;11)/MLL-AF4 positive B-cell acute lymphoblastic leukemia: results of the prospective multicenter LALA-94 study. *Leukemia* 2006;20:2155-2161. Available at: <http://www.ncbi.nlm.nih.gov/pubmed/17039234>.

69. Thiebaut A, Vernant JP, Degos L, et al. Adult acute lymphocytic leukemia study testing chemotherapy and autologous and allogeneic transplantation. A follow-up report of the French protocol LALA 87. *Hematol Oncol Clin North Am* 2000;14:1353-1366, x. Available at: <http://www.ncbi.nlm.nih.gov/pubmed/11147227>.

70. Nachman J. Clinical characteristics, biologic features and outcome for young adult patients with acute lymphoblastic leukaemia. *Br J Haematol* 2005;130:166-173. Available at: <http://www.ncbi.nlm.nih.gov/pubmed/16029445>.

71. Aguiar RC, Sohal J, van Rhee F, et al. TEL-AML1 fusion in acute lymphoblastic leukaemia of adults. M.R.C. Adult Leukaemia Working Party. *Br J Haematol* 1996;95:673-677. Available at: <http://www.ncbi.nlm.nih.gov/pubmed/8982044>.

72. Secker-Walker LM, Craig JM, Hawkins JM, Hoffbrand AV. Philadelphia positive acute lymphoblastic leukemia in adults: age distribution, BCR breakpoint and prognostic significance. *Leukemia* 1991;5:196-199. Available at: <http://www.ncbi.nlm.nih.gov/pubmed/2013979>.

73. Neumann M, Heesch S, Gokbuget N, et al. Clinical and molecular characterization of early T-cell precursor leukemia: a high-risk subgroup in adult T-ALL with a high frequency of FLT3 mutations. *Blood Cancer J* 2012;2:e55. Available at: <http://www.ncbi.nlm.nih.gov/pubmed/22829239>.

74. Pieters R, Kaspers GJ, Klumper E, Veerman AJ. Clinical relevance of in vitro drug resistance testing in childhood acute lymphoblastic leukemia: the state of the art. *Med Pediatr Oncol* 1994;22:299-308. Available at: <http://www.ncbi.nlm.nih.gov/pubmed/8127253>.

75. Raetz EA, Devidas M, Carroll AJ, et al. Cytogenetic and early-response characteristics of adolescents and young adults with acute lymphoblastic leukemia (ALL): A Children's Oncology Group (COG) study [abstract]. *J Clin Oncol* 2010;28:Abstract 9509. Available at: http://meeting.ascopubs.org/cgi/content/abstract/28/15_suppl/9509.

76. Bleyer A, Budd T, Montello M. Adolescents and young adults with cancer: the scope of the problem and criticality of clinical trials. *Cancer* 2006;107:1645-1655. Available at: <http://www.ncbi.nlm.nih.gov/pubmed/16906507>.

77. Fern LA, Whelan JS. Recruitment of adolescents and young adults to cancer clinical trials--international comparisons, barriers, and implications. *Semin Oncol* 2010;37:e1-8. Available at: <http://www.ncbi.nlm.nih.gov/pubmed/20494693>.

78. Schmiegelow K, Heyman M, Gustafsson G, et al. The degree of myelosuppression during maintenance therapy of adolescents with B-lineage intermediate risk acute lymphoblastic leukemia predicts risk of relapse. *Leukemia* 2010;24:715-720. Available at: <http://www.ncbi.nlm.nih.gov/pubmed/20130603>.

79. Martin S, Ulrich C, Munsell M, et al. Delays in cancer diagnosis in underinsured young adults and older adolescents. *Oncologist* 2007;12:816-824. Available at: <http://www.ncbi.nlm.nih.gov/pubmed/17673613>.

80. Hoelzer D, Thiel E, Loffler H, et al. Intensified therapy in acute lymphoblastic and acute undifferentiated leukemia in adults. *Blood* 1984;64:38-47. Available at: <http://www.ncbi.nlm.nih.gov/pubmed/6375764>.

81. Hoelzer D, Thiel E, Loffler H, et al. Prognostic factors in a multicenter study for treatment of acute lymphoblastic leukemia in adults. *Blood* 1988;71:123-131. Available at: <http://www.ncbi.nlm.nih.gov/pubmed/3422030>.

82. Rowe JM, Buck G, Burnett AK, et al. Induction therapy for adults with acute lymphoblastic leukemia: results of more than 1500 patients from the international ALL trial: MRC UKALL XII/ECOG E2993. *Blood* 2005;106:3760-3767. Available at: <http://www.ncbi.nlm.nih.gov/pubmed/16105981>.

83. Moorman AV, Harrison CJ, Buck GAN, et al. Karyotype is an independent prognostic factor in adult acute lymphoblastic leukemia (ALL): analysis of cytogenetic data from patients treated on the Medical Research Council (MRC) UKALLXII/Eastern Cooperative Oncology Group (ECOG) 2993 trial. *Blood* 2007;109:3189-3197. Available at: <http://www.ncbi.nlm.nih.gov/pubmed/17170120>.

84. Charrin C, Thomas X, Ffrench M, et al. A report from the LALA-94 and LALA-SA groups on hypodiploidy with 30 to 39 chromosomes and near-triploidy: 2 possible expressions of a sole entity conferring poor prognosis in adult acute lymphoblastic leukemia (ALL). *Blood* 2004;104:2444-2451. Available at: <http://www.ncbi.nlm.nih.gov/pubmed/15039281>.

85. Pullarkat V, Slovak ML, Kopecky KJ, et al. Impact of cytogenetics on the outcome of adult acute lymphoblastic leukemia: results of Southwest Oncology Group 9400 study. *Blood* 2008;111:2563-2572. Available at: <http://www.ncbi.nlm.nih.gov/pubmed/18156492>.

86. Kamps WA, Bokkerink JP, Hakvoort-Cammel FG, et al. BFM-oriented treatment for children with acute lymphoblastic leukemia without cranial irradiation and treatment reduction for standard risk patients: results of DCLSG protocol ALL-8 (1991-1996). *Leukemia* 2002;16:1099-1111. Available at: <http://www.ncbi.nlm.nih.gov/pubmed/12040440>.

87. Moricke A, Reiter A, Zimmermann M, et al. Risk-adjusted therapy of acute lymphoblastic leukemia can decrease treatment burden and improve survival: treatment results of 2169 unselected pediatric and adolescent patients enrolled in the trial ALL-BFM 95. *Blood* 2008;111:4477-4489. Available at: <http://www.ncbi.nlm.nih.gov/pubmed/18285545>.

88. Schrappe M, Reiter A, Ludwig WD, et al. Improved outcome in childhood acute lymphoblastic leukemia despite reduced use of anthracyclines and cranial radiotherapy: results of trial ALL-BFM 90. German-Austrian-Swiss ALL-BFM Study Group. *Blood* 2000;95:3310-3322. Available at: <http://www.ncbi.nlm.nih.gov/pubmed/10828010>.
89. Seibel NL, Steinherz PG, Sather HN, et al. Early postinduction intensification therapy improves survival for children and adolescents with high-risk acute lymphoblastic leukemia: a report from the Children's Oncology Group. *Blood* 2008;111:2548-2555. Available at: <http://www.ncbi.nlm.nih.gov/pubmed/18039957>.
90. Stock W, La M, Sanford B, et al. What determines the outcomes for adolescents and young adults with acute lymphoblastic leukemia treated on cooperative group protocols? A comparison of Children's Cancer Group and Cancer and Leukemia Group B studies. *Blood* 2008;112:1646-1654. Available at: <http://www.ncbi.nlm.nih.gov/pubmed/18502832>.
91. Larson RA, Dodge RK, Burns CP, et al. A five-drug remission induction regimen with intensive consolidation for adults with acute lymphoblastic leukemia: cancer and leukemia group B study 8811. *Blood* 1995;85:2025-2037. Available at: <http://www.ncbi.nlm.nih.gov/pubmed/7718875>.
92. Bostrom BC, Sensel MR, Sather HN, et al. Dexamethasone versus prednisone and daily oral versus weekly intravenous mercaptopurine for patients with standard-risk acute lymphoblastic leukemia: a report from the Children's Cancer Group. *Blood* 2003;101:3809-3817. Available at: <http://www.ncbi.nlm.nih.gov/pubmed/12531809>.
93. Mitchell CD, Richards SM, Kinsey SE, et al. Benefit of dexamethasone compared with prednisolone for childhood acute lymphoblastic leukaemia: results of the UK Medical Research Council ALL97 randomized trial. *Br J Haematol* 2005;129:734-745. Available at: <http://www.ncbi.nlm.nih.gov/pubmed/15952999>.
94. Pui CH. Central nervous system disease in acute lymphoblastic leukemia: prophylaxis and treatment. *Hematology Am Soc Hematol Educ Program* 2006:142-146. Available at: <http://www.ncbi.nlm.nih.gov/pubmed/17124053>.
95. Teuffel O, Kuster SP, Hunger SP, et al. Dexamethasone versus prednisone for induction therapy in childhood acute lymphoblastic leukemia: a systematic review and meta-analysis. *Leukemia* 2011;1232-1238. Available at: <http://www.ncbi.nlm.nih.gov/pubmed/21527934>.
96. Kantarjian H, Thomas D, O'Brien S, et al. Long-term follow-up results of hyperfractionated cyclophosphamide, vincristine, doxorubicin, and dexamethasone (Hyper-CVAD), a dose-intensive regimen, in adult acute lymphocytic leukemia. *Cancer* 2004;101:2788-2801. Available at: <http://www.ncbi.nlm.nih.gov/pubmed/15481055>.
97. Kantarjian HM, O'Brien S, Smith TL, et al. Results of treatment with hyper-CVAD, a dose-intensive regimen, in adult acute lymphocytic leukemia. *J Clin Oncol* 2000;18:547-561. Available at: <http://www.ncbi.nlm.nih.gov/pubmed/10653870>.
98. Koller CA, Kantarjian HM, Thomas D, et al. The hyper-CVAD regimen improves outcome in relapsed acute lymphoblastic leukemia. *Leukemia* 1997;11:2039-2044. Available at: <http://www.ncbi.nlm.nih.gov/pubmed/9447817>.
99. Hoelzer D, Ludwig WD, Thiel E, et al. Improved outcome in adult B-cell acute lymphoblastic leukemia. *Blood* 1996;87:495-508. Available at: <http://www.ncbi.nlm.nih.gov/pubmed/8555471>.
100. Chrzanowska M, Kolecki P, Duczmal-Cichocka B, Fiet J. Metabolites of mercaptopurine in red blood cells: a relationship between 6-thioguanine nucleotides and 6-methylmercaptopurine metabolite concentrations in children with lymphoblastic leukemia. *Eur J Pharm Sci* 1999;8:329-334. Available at: <http://www.ncbi.nlm.nih.gov/pubmed/10425383>.

101. Lennard L, Lilleyman JS. Variable mercaptopurine metabolism and treatment outcome in childhood lymphoblastic leukemia. *J Clin Oncol* 1989;7:1816-1823. Available at: <http://www.ncbi.nlm.nih.gov/pubmed/2585022>.
102. McLeod HL, Relling MV, Crom WR, et al. Disposition of antineoplastic agents in the very young child. *Br J Cancer Suppl* 1992;18:S23-29. Available at: <http://www.ncbi.nlm.nih.gov/pubmed/1503923>.
103. Hawwa AF, Collier PS, Millership JS, et al. Population pharmacokinetic and pharmacogenetic analysis of 6-mercaptopurine in paediatric patients with acute lymphoblastic leukaemia. *Br J Clin Pharmacol* 2008;66:826-837. Available at: <http://www.ncbi.nlm.nih.gov/pubmed/18823306>.
104. McLeod HL, Coulthard S, Thomas AE, et al. Analysis of thiopurine methyltransferase variant alleles in childhood acute lymphoblastic leukaemia. *Br J Haematol* 1999;105:696-700. Available at: <http://www.ncbi.nlm.nih.gov/pubmed/10354134>.
105. Bhatia S, Landier W, Shangguan M, et al. Nonadherence to oral mercaptopurine and risk of relapse in Hispanic and non-Hispanic white children with acute lymphoblastic leukemia: a report from the children's oncology group. *J Clin Oncol* 2012;30:2094-2101. Available at: <http://www.ncbi.nlm.nih.gov/pubmed/22564992>.
106. Grant DM, Tang BK, Kalow W. Variability in caffeine metabolism. *Clin Pharmacol Ther* 1983;33:591-602. Available at: <http://www.ncbi.nlm.nih.gov/pubmed/6687705>.
107. Grant DM, Tang BK, Campbell ME, Kalow W. Effect of allopurinol on caffeine disposition in man. *Br J Clin Pharmacol* 1986;21:454-458. Available at: <http://www.ncbi.nlm.nih.gov/pubmed/3754760>.
108. Burton NK, Barnett MJ, Aherne GW, et al. The effect of food on the oral administration of 6-mercaptopurine. *Cancer Chemother Pharmacol* 1986;18:90-91. Available at: <http://www.ncbi.nlm.nih.gov/pubmed/3757164>.
109. Riccardi R, Balis FM, Ferrara P, et al. Influence of food intake on bioavailability of oral 6-mercaptopurine in children with acute lymphoblastic leukemia. *Pediatr Hematol Oncol* 1986;3:319-324. Available at: <http://www.ncbi.nlm.nih.gov/pubmed/3153245>.
110. Weinshilboum RM, Sladek SL. Mercaptopurine pharmacogenetics: monogenic inheritance of erythrocyte thiopurine methyltransferase activity. *Am J Hum Genet* 1980;32:651-662. Available at: <http://www.ncbi.nlm.nih.gov/pubmed/7191632>.
111. Evans WE, Horner M, Chu YQ, et al. Altered mercaptopurine metabolism, toxic effects, and dosage requirement in a thiopurine methyltransferase-deficient child with acute lymphocytic leukemia. *J Pediatr* 1991;119:985-989. Available at: <http://www.ncbi.nlm.nih.gov/pubmed/1960624>.
112. Lennard L, Gibson BE, Nicole T, Lilleyman JS. Congenital thiopurine methyltransferase deficiency and 6-mercaptopurine toxicity during treatment for acute lymphoblastic leukaemia. *Arch Dis Child* 1993;69:577-579. Available at: <http://www.ncbi.nlm.nih.gov/pubmed/8257179>.
113. McLeod HL, Lin JS, Scott EP, et al. Thiopurine methyltransferase activity in American white subjects and black subjects. *Clin Pharmacol Ther* 1994;55:15-20. Available at: <http://www.ncbi.nlm.nih.gov/pubmed/8299312>.
114. Collie-Duguid ES, Pritchard SC, Powrie RH, et al. The frequency and distribution of thiopurine methyltransferase alleles in Caucasian and Asian populations. *Pharmacogenetics* 1999;9:37-42. Available at: <http://www.ncbi.nlm.nih.gov/pubmed/10208641>.
115. Lennard L, Lilleyman JS. Individualizing therapy with 6-mercaptopurine and 6-thioguanine related to the thiopurine

methyltransferase genetic polymorphism. *Ther Drug Monit* 1996;18:328-334. Available at: <http://www.ncbi.nlm.nih.gov/pubmed/8857546>.

116. Relling MV, Hancock ML, Rivera GK, et al. Mercaptopurine therapy intolerance and heterozygosity at the thiopurine S-methyltransferase gene locus. *J Natl Cancer Inst* 1999;91:2001-2008. Available at: <http://www.ncbi.nlm.nih.gov/pubmed/10580024>.

117. Relling MV, Gardner EE, Sandborn WJ, et al. Clinical pharmacogenetics implementation consortium guidelines for thiopurine methyltransferase genotype and thiopurine dosing: 2013 update. *Clin Pharmacol Ther* 2013;93:324-325. Available at: <http://www.ncbi.nlm.nih.gov/pubmed/23422873>.

118. Relling MV, Gardner EE, Sandborn WJ, et al. Clinical Pharmacogenetics Implementation Consortium guidelines for thiopurine methyltransferase genotype and thiopurine dosing. *Clin Pharmacol Ther* 2011;89:387-391. Available at: <http://www.ncbi.nlm.nih.gov/pubmed/21270794>.

119. U.S. Food and Drug Administration. Prescribing information. PURIXAN (mercaptopurine) oral suspension. 2014. Available at: http://www.accessdata.fda.gov/drugsatfda_docs/label/2014/205919s001lbl.pdf. Accessed September 29, 2016.

120. Hanff LM, Mathot RA, Smeets O, et al. A novel 6-mercaptopurine oral liquid formulation for pediatric acute lymphoblastic leukemia patients - results of a randomized clinical trial. *Int J Clin Pharmacol Ther* 2014;52:653-662. Available at: <http://www.ncbi.nlm.nih.gov/pubmed/24800919>.

121. Chessells JM, Harrison G, Lilleyman JS, et al. Continuing (maintenance) therapy in lymphoblastic leukaemia: lessons from MRC UKALL X. Medical Research Council Working Party in Childhood Leukaemia. *Br J Haematol* 1997;98:945-951. Available at: <http://www.ncbi.nlm.nih.gov/pubmed/9326194>.

122. Ottmann OG, Druker BJ, Sawyers CL, et al. A phase 2 study of imatinib in patients with relapsed or refractory Philadelphia chromosome-positive acute lymphoid leukemias. *Blood* 2002;100:1965-1971. Available at: <http://www.ncbi.nlm.nih.gov/pubmed/12200353>.

123. Wassmann B, Gokbuget N, Scheuring UJ, et al. A randomized multicenter open label phase II study to determine the safety and efficacy of induction therapy with imatinib (Glivec, formerly STI571) in comparison with standard induction chemotherapy in elderly (>55 years) patients with Philadelphia chromosome-positive (Ph+/BCR-ABL+) acute lymphoblastic leukemia (ALL) (CSTI571ADE 10). *Ann Hematol* 2003;82:716-720. Available at: <http://www.ncbi.nlm.nih.gov/pubmed/14648032>.

124. Ottmann OG, Wassmann B, Pfeifer H, et al. Imatinib compared with chemotherapy as front-line treatment of elderly patients with Philadelphia chromosome-positive acute lymphoblastic leukemia (Ph+ALL). *Cancer* 2007;109:2068-2076. Available at: <http://www.ncbi.nlm.nih.gov/pubmed/17429836>.

125. Thomas DA, Faderl S, Cortes J, et al. Treatment of Philadelphia chromosome-positive acute lymphocytic leukemia with hyper-CVAD and imatinib mesylate. *Blood* 2004;103:4396-4407. Available at: <http://www.ncbi.nlm.nih.gov/pubmed/14551133>.

126. Towatari M, Yanada M, Usui N, et al. Combination of intensive chemotherapy and imatinib can rapidly induce high-quality complete remission for a majority of patients with newly diagnosed BCR-ABL-positive acute lymphoblastic leukemia. *Blood* 2004;104:3507-3512. Available at: <http://www.ncbi.nlm.nih.gov/pubmed/15315963>.

127. Wassmann B, Pfeifer H, Goekbuget N, et al. Alternating versus concurrent schedules of imatinib and chemotherapy as front-line therapy for Philadelphia-positive acute lymphoblastic leukemia (Ph+ALL). *Blood* 2006;108:1469-1477. Available at: <http://www.ncbi.nlm.nih.gov/pubmed/16638934>.

128. Yanada M, Takeuchi J, Sugiura I, et al. High complete remission rate and promising outcome by combination of imatinib and chemotherapy for newly diagnosed BCR-ABL-positive acute lymphoblastic leukemia: a phase II study by the Japan Adult Leukemia Study Group. *J Clin Oncol* 2006;24:460-466. Available at: <http://www.ncbi.nlm.nih.gov/pubmed/16344315>.

129. de Labarthe A, Rousselot P, Huguet-Rigal F, et al. Imatinib combined with induction or consolidation chemotherapy in patients with de novo Philadelphia chromosome-positive acute lymphoblastic leukemia: results of the GRAAPH-2003 study. *Blood* 2007;109:1408-1413. Available at: <http://www.ncbi.nlm.nih.gov/pubmed/17062730>.

130. Tanguy-Schmidt A, Rousselot P, Chalandon Y, et al. Long-term follow-up of the imatinib GRAAPH-2003 study in newly diagnosed patients with de novo Philadelphia chromosome-positive acute lymphoblastic leukemia: A GRAALL study. *Biology of blood and marrow transplantation: Journal of the American Society for Blood and Marrow Transplantation* 2013;19:150-155. Available at: <http://linkinghub.elsevier.com/retrieve/pii/S1083879112003552?showall=true>.

131. Thomas DA, O'Brien SM, Faderl S, et al. Long-term outcome after hyper-CVAD and imatinib (IM) for de novo or minimally treated Philadelphia chromosome-positive acute lymphoblastic leukemia (Ph-ALL) [abstract]. *J Clin Oncol* 2010;28:Abstract 6506. Available at: http://meeting.ascopubs.org/cgi/content/abstract/28/15_suppl/6506.

132. O'Hare T, Walters DK, Stoffregen EP, et al. In vitro activity of Bcr-Abl inhibitors AMN107 and BMS-354825 against clinically relevant imatinib-resistant Abl kinase domain mutants. *Cancer Res* 2005;65:4500-4505. Available at: <http://www.ncbi.nlm.nih.gov/pubmed/15930265>.

133. Shah NP, Tran C, Lee FY, et al. Overriding imatinib resistance with a novel ABL kinase inhibitor. *Science* 2004;305:399-401. Available at: <http://www.ncbi.nlm.nih.gov/pubmed/15256671>.

134. Talpaz M, Shah NP, Kantarjian H, et al. Dasatinib in imatinib-resistant Philadelphia chromosome-positive leukemias. *N Engl J Med* 2006;354:2531-2541. Available at: <http://www.ncbi.nlm.nih.gov/pubmed/16775234>.

135. Ottmann O, Dombret H, Martinelli G, et al. Dasatinib induces rapid hematologic and cytogenetic responses in adult patients with Philadelphia chromosome positive acute lymphoblastic leukemia with resistance or intolerance to imatinib: interim results of a phase 2 study. *Blood* 2007;110:2309-2315. Available at: <http://www.ncbi.nlm.nih.gov/pubmed/17496201>.

136. Lilly MB, Ottmann OG, Shah NP, et al. Dasatinib 140 mg once daily versus 70 mg twice daily in patients with Ph-positive acute lymphoblastic leukemia who failed imatinib: Results from a phase 3 study. *Am J Hematol* 2010;85:164-170. Available at: <http://www.ncbi.nlm.nih.gov/pubmed/20131302>.

137. Porkka K, Koskenvesa P, Lundan T, et al. Dasatinib crosses the blood-brain barrier and is an efficient therapy for central nervous system Philadelphia chromosome-positive leukemia. *Blood* 2008;112:1005-1012. Available at: <http://www.ncbi.nlm.nih.gov/pubmed/18477770>.

138. Foa R, Vitale A, Vignetti M, et al. Dasatinib as first-line treatment for adult patients with Philadelphia chromosome-positive acute lymphoblastic leukemia. *Blood* 2011;118:6521-6528. Available at: <http://www.ncbi.nlm.nih.gov/pubmed/21931113>.

139. Di Gion P, Kanefendt F, Lindauer A, et al. Clinical pharmacokinetics of tyrosine kinase inhibitors: focus on pyrimidines, pyridines and pyrroles. *Clin Pharmacokinet* 2011;50:551-603. Available at: <http://www.ncbi.nlm.nih.gov/pubmed/21827214>.

140. Thomas DA, Faderl S, O'Brien S, et al. Chemoimmunotherapy with hyper-CVAD plus rituximab for the treatment of adult Burkitt and Burkitt-type lymphoma or acute lymphoblastic leukemia. *Cancer* 2006;106:1569-1580. Available at: <http://www.ncbi.nlm.nih.gov/pubmed/16502413>.

141. Thomas DA, O'Brien S, Faderl S, et al. Chemoimmunotherapy with a modified hyper-CVAD and rituximab regimen improves outcome in de novo Philadelphia chromosome-negative precursor B-lineage acute lymphoblastic leukemia. *J Clin Oncol* 2010;28:3880-3889. Available at: <http://www.ncbi.nlm.nih.gov/pubmed/20660823>.
142. Berg SL, Blaney SM, Devidas M, et al. Phase II study of nelarabine (compound 506U78) in children and young adults with refractory T-cell malignancies: a report from the Children's Oncology Group. *J Clin Oncol* 2005;23:3376-3382. Available at: <http://www.ncbi.nlm.nih.gov/pubmed/15908649>.
143. Cohen MH, Johnson JR, Justice R, Pazdur R. FDA drug approval summary: nelarabine (Arranon) for the treatment of T-cell lymphoblastic leukemia/lymphoma. *Oncologist* 2008;13:709-714. Available at: <http://www.ncbi.nlm.nih.gov/pubmed/18586926>.
144. DeAngelo DJ, Yu D, Johnson JL, et al. Nelarabine induces complete remissions in adults with relapsed or refractory T-lineage acute lymphoblastic leukemia or lymphoblastic lymphoma: Cancer and Leukemia Group B study 19801. *Blood* 2007;109:5136-5142. Available at: <http://www.ncbi.nlm.nih.gov/pubmed/17344466>.
145. Arico M, Schrappe M, Hunger SP, et al. Clinical outcome of children with newly diagnosed Philadelphia chromosome-positive acute lymphoblastic leukemia treated between 1995 and 2005. *J Clin Oncol* 2010;28:4755-4761. Available at: <http://www.ncbi.nlm.nih.gov/pubmed/20876426>.
146. Schultz KR, Bowman WP, Aledo A, et al. Improved early event-free survival with imatinib in Philadelphia chromosome-positive acute lymphoblastic leukemia: a children's oncology group study. *J Clin Oncol* 2009;27:5175-5181. Available at: <http://www.ncbi.nlm.nih.gov/pubmed/19805687>.
147. Biondi A, Schrappe M, De Lorenzo P, et al. Imatinib after induction for treatment of children and adolescents with Philadelphia-chromosome-positive acute lymphoblastic leukaemia (EsPhALL): a randomised, open-label, intergroup study. *Lancet Oncol* 2012;13:936-945. Available at: <http://www.ncbi.nlm.nih.gov/pubmed/22898679>.
148. Ravandi F, O'Brien S, Thomas D, et al. First report of phase 2 study of dasatinib with hyper-CVAD for the frontline treatment of patients with Philadelphia chromosome-positive (Ph+) acute lymphoblastic leukemia. *Blood* 2010;116:2070-2077. Available at: <http://www.ncbi.nlm.nih.gov/pubmed/20466853>.
149. Bassan R, Rossi G, Pogliani EM, et al. Chemotherapy-phased imatinib pulses improve long-term outcome of adult patients with Philadelphia chromosome-positive acute lymphoblastic leukemia: Northern Italy Leukemia Group protocol 09/00. *J Clin Oncol* 2010;28:3644-3652. Available at: <http://www.ncbi.nlm.nih.gov/pubmed/20606084>.
150. Ribera JM, Oriol A, Gonzalez M, et al. Concurrent intensive chemotherapy and imatinib before and after stem cell transplantation in newly diagnosed Philadelphia chromosome-positive acute lymphoblastic leukemia. Final results of the CSTIBES02 trial. *Haematologica* 2010;95:87-95. Available at: <http://www.ncbi.nlm.nih.gov/pubmed/19797728>.
151. Mizuta S, Matsuo K, Yagasaki F, et al. Pre-transplant imatinib-based therapy improves the outcome of allogeneic hematopoietic stem cell transplantation for BCR-ABL-positive acute lymphoblastic leukemia. *Leukemia* 2011;25:41-47. Available at: <http://www.ncbi.nlm.nih.gov/pubmed/20944676>.
152. Cornelissen JJ, Carston M, Kollman C, et al. Unrelated marrow transplantation for adult patients with poor-risk acute lymphoblastic leukemia: strong graft-versus-leukemia effect and risk factors determining outcome. *Blood* 2001;97:1572-1577. Available at: <http://www.ncbi.nlm.nih.gov/pubmed/11238093>.
153. Esperou H, Boiron JM, Cayuela JM, et al. A potential graft-versus-leukemia effect after allogeneic hematopoietic stem cell transplantation for patients with Philadelphia chromosome-positive acute lymphoblastic

leukemia: results from the French Bone Marrow Transplantation Society. Bone Marrow Transplant 2003;31:909-918. Available at: <http://www.ncbi.nlm.nih.gov/pubmed/12748668>.

154. Fielding AK, Rowe JM, Richards SM, et al. Prospective outcome data on 267 unselected adult patients with Philadelphia chromosome-positive acute lymphoblastic leukemia confirms superiority of allogeneic transplantation over chemotherapy in the pre-imatinib era: results from the International ALL Trial MRC UKALLXII/ECOG2993. Blood 2009;113:4489-4496. Available at: <http://www.ncbi.nlm.nih.gov/pubmed/19244158>.

155. Thomas DA, Kantarjian HM, Cortes J, et al. Outcome after frontline therapy with the hyper-CVAD and imatinib mesylate regimen for adults with de novo or minimally treated Philadelphia chromosome (Ph) positive acute lymphoblastic leukemia (ALL) [abstract]. Blood 2008;112(Supple 11):Abstract 2931. Available at: <http://abstracts.hematologylibrary.org/cgi/content/abstract/ashmtg;112/1/2931>.

156. Delannoy A, Delabesse E, Lheritier V, et al. Imatinib and methylprednisolone alternated with chemotherapy improve the outcome of elderly patients with Philadelphia-positive acute lymphoblastic leukemia: results of the GRAALL AFR09 study. Leukemia 2006;20:1526-1532. Available at: <http://www.ncbi.nlm.nih.gov/pubmed/16838024>.

157. Vignetti M, Fazi P, Cimino G, et al. Imatinib plus steroids induces complete remissions and prolonged survival in elderly Philadelphia chromosome-positive patients with acute lymphoblastic leukemia without additional chemotherapy: results of the Gruppo Italiano Malattie Ematologiche dell'Adulto (GIMEMA) LAL0201-B protocol. Blood 2007;109:3676-3678. Available at: <http://www.ncbi.nlm.nih.gov/pubmed/17213285>.

158. Chalandon Y, Thomas X, Hayette S, et al. First results of the GRAAPH-2005 study in younger adult patients with de novo Philadelphia positive acute lymphoblastic leukemia [abstract]. Blood

2008;112:Abstract 12. Available at: <http://abstracts.hematologylibrary.org/cgi/content/abstract/ashmtg;112/1/12>.

159. Chalandon Y, Thomas X, Hayette S, et al. Is less chemotherapy detrimental in adults with Philadelphia chromosome (Ph)-positive acute lymphoblastic leukemia (ALL) treated with high-dose imatinib? Results of the prospective randomized GRAAPH-2005 study [abstract]. Blood 2012;120:Abstract 138. Available at: <http://abstracts.hematologylibrary.org/cgi/content/abstract/ashmtg;120/2/1/138>.

160. Rousselot P, Coude MM, Huguet F, et al. Dasatinib (Sprycel(R)) and low intensity chemotherapy for first-line treatment in patients with de novo Philadelphia positive ALL aged 55 and Over: Final results of the EWALL-Ph-01 study [abstract]. Blood 2012;120:Abstract 666. Available at: <http://abstracts.hematologylibrary.org/cgi/content/abstract/ashmtg;120/2/1/666>.

161. Carpenter PA, Snyder DS, Flowers ME, et al. Prophylactic administration of imatinib after hematopoietic cell transplantation for high-risk Philadelphia chromosome-positive leukemia. Blood 2007;109:2791-2793. Available at: <http://www.ncbi.nlm.nih.gov/pubmed/17119111>.

162. Chen H, Liu KY, Xu LP, et al. Administration of imatinib after allogeneic hematopoietic stem cell transplantation may improve disease-free survival for patients with Philadelphia chromosome-positive acute lymphoblastic leukemia. J Hematol Oncol 2012;5:29. Available at: <http://www.ncbi.nlm.nih.gov/pubmed/22682059>.

163. Pfeifer H, Wassmann B, Bethge W, et al. Randomized comparison of prophylactic and minimal residual disease-triggered imatinib after allogeneic stem cell transplantation for BCR-ABL1-positive acute lymphoblastic leukemia. Leukemia 2013;27:1254-1262. Available at: <http://www.ncbi.nlm.nih.gov/pubmed/23212150>.

164. Fielding AK, Richards SM, Chopra R, et al. Outcome of 609 adults after relapse of acute lymphoblastic leukemia (ALL); an MRC UKALL12/ECOG 2993 study. *Blood* 2007;109:944-950. Available at: <http://www.ncbi.nlm.nih.gov/pubmed/17032921>.
165. Oriol A, Vives S, Hernandez-Rivas JM, et al. Outcome after relapse of acute lymphoblastic leukemia in adult patients included in four consecutive risk-adapted trials by the PETHEMA Study Group. *Haematologica* 2010;95:589-596. Available at: <http://www.ncbi.nlm.nih.gov/pubmed/20145276>.
166. Tavernier E, Boiron JM, Huguet F, et al. Outcome of treatment after first relapse in adults with acute lymphoblastic leukemia initially treated by the LALA-94 trial. *Leukemia* 2007;21:1907-1914. Available at: <http://www.ncbi.nlm.nih.gov/pubmed/17611565>.
167. Thomas DA, Kantarjian H, Smith TL, et al. Primary refractory and relapsed adult acute lymphoblastic leukemia: characteristics, treatment results, and prognosis with salvage therapy. *Cancer* 1999;86:1216-1230. Available at: <http://www.ncbi.nlm.nih.gov/pubmed/10506707>.
168. Bujassoum S, Rifkind J, Lipton JH. Isolated central nervous system relapse in lymphoid blast crisis chronic myeloid leukemia and acute lymphoblastic leukemia in patients on imatinib therapy. *Leuk Lymphoma* 2004;45:401-403. Available at: <http://www.ncbi.nlm.nih.gov/pubmed/15101732>.
169. Leis JF, Stepan DE, Curtin PT, et al. Central nervous system failure in patients with chronic myelogenous leukemia lymphoid blast crisis and Philadelphia chromosome positive acute lymphoblastic leukemia treated with imatinib (STI-571). *Leuk Lymphoma* 2004;45:695-698. Available at: <http://www.ncbi.nlm.nih.gov/pubmed/15160941>.
170. Pfeifer H, Wassmann B, Hofmann WK, et al. Risk and prognosis of central nervous system leukemia in patients with Philadelphia chromosome-positive acute leukemias treated with imatinib mesylate. *Clin Cancer Res* 2003;9:4674-4681. Available at: <http://www.ncbi.nlm.nih.gov/pubmed/14581336>.
171. Takayama N, Sato N, O'Brien SG, et al. Imatinib mesylate has limited activity against the central nervous system involvement of Philadelphia chromosome-positive acute lymphoblastic leukaemia due to poor penetration into cerebrospinal fluid. *Br J Haematol* 2002;119:106-108. Available at: <http://www.ncbi.nlm.nih.gov/pubmed/12358909>.
172. Branford S, Rudzki Z, Walsh S, et al. High frequency of point mutations clustered within the adenosine triphosphate-binding region of BCR/ABL in patients with chronic myeloid leukemia or Ph-positive acute lymphoblastic leukemia who develop imatinib (STI571) resistance. *Blood* 2002;99:3472-3475. Available at: <http://www.ncbi.nlm.nih.gov/pubmed/11964322>.
173. Hofmann WK, Jones LC, Lemp NA, et al. Ph(+) acute lymphoblastic leukemia resistant to the tyrosine kinase inhibitor STI571 has a unique BCR-ABL gene mutation. *Blood* 2002;99:1860-1862. Available at: <http://www.ncbi.nlm.nih.gov/pubmed/11861307>.
174. Hu Y, Liu Y, Pelletier S, et al. Requirement of Src kinases Lyn, Hck and Fgr for BCR-ABL1-induced B-lymphoblastic leukemia but not chronic myeloid leukemia. *Nat Genet* 2004;36:453-461. Available at: <http://www.ncbi.nlm.nih.gov/pubmed/15098032>.
175. Jones D, Thomas D, Yin CC, et al. Kinase domain point mutations in Philadelphia chromosome-positive acute lymphoblastic leukemia emerge after therapy with BCR-ABL kinase inhibitors. *Cancer* 2008;113:985-994. Available at: <http://www.ncbi.nlm.nih.gov/pubmed/18615627>.
176. Soverini S, Colarossi S, Gnani A, et al. Contribution of ABL kinase domain mutations to imatinib resistance in different subsets of Philadelphia-positive patients: by the GIMEMA Working Party on Chronic Myeloid Leukemia. *Clin Cancer Res* 2006;12:7374-7379. Available at: <http://www.ncbi.nlm.nih.gov/pubmed/17189410>.
177. Hofmann WK, Komor M, Wassmann B, et al. Presence of the BCR-ABL mutation Glu255Lys prior to STI571 (imatinib) treatment in

patients with Ph+ acute lymphoblastic leukemia. *Blood* 2003;102:659-661. Available at: <http://www.ncbi.nlm.nih.gov/pubmed/12663457>.

178. Pfeifer H, Wassmann B, Pavlova A, et al. Kinase domain mutations of BCR-ABL frequently precede imatinib-based therapy and give rise to relapse in patients with de novo Philadelphia-positive acute lymphoblastic leukemia (Ph+ ALL). *Blood* 2007;110:727-734. Available at: <http://www.ncbi.nlm.nih.gov/pubmed/17405907>.

179. Redaelli S, Piazza R, Rostagno R, et al. Activity of bosutinib, dasatinib, and nilotinib against 18 imatinib-resistant BCR/ABL mutants. *J Clin Oncol* 2009;27:469-471. Available at: <http://www.ncbi.nlm.nih.gov/pubmed/19075254>.

180. Verstovsek S, Golemovic M, Kantarjian H, et al. AMN107, a novel aminopyrimidine inhibitor of p190 Bcr-Abl activation and of in vitro proliferation of Philadelphia-positive acute lymphoblastic leukemia cells. *Cancer* 2005;104:1230-1236. Available at: <http://www.ncbi.nlm.nih.gov/pubmed/16078266>.

181. Kantarjian H, Giles F, Wunderle L, et al. Nilotinib in imatinib-resistant CML and Philadelphia chromosome-positive ALL. *N Engl J Med* 2006;354:2542-2551. Available at: <http://www.ncbi.nlm.nih.gov/pubmed/16775235>.

182. Ottmann OG, Larson RA, Kantarjian HM, et al. Phase II study of nilotinib in patients with relapsed or refractory Philadelphia chromosome--positive acute lymphoblastic leukemia. *Leukemia* 2013;27:1411-1413. Available at: <http://www.ncbi.nlm.nih.gov/pubmed/23138184>.

183. Benjamini O, Dumlaio TL, Kantarjian H, et al. Phase II trial of hyper CVAD and dasatinib in patients with relapsed Philadelphia chromosome positive acute lymphoblastic leukemia or blast phase chronic myeloid leukemia. *Am J Hematol* 2014;89:282-287. Available at: <http://www.ncbi.nlm.nih.gov/pubmed/24779033>.

184. Muller MC, Cortes JE, Kim DW, et al. Dasatinib treatment of chronic-phase chronic myeloid leukemia: analysis of responses according to preexisting BCR-ABL mutations. *Blood* 2009;114:4944-4953. Available at: <http://www.ncbi.nlm.nih.gov/pubmed/19779040>.

185. Soverini S, Colarossi S, Gnani A, et al. Resistance to dasatinib in Philadelphia-positive leukemia patients and the presence or the selection of mutations at residues 315 and 317 in the BCR-ABL kinase domain. *Haematologica* 2007;92:401-404. Available at: <http://www.ncbi.nlm.nih.gov/pubmed/17339191>.

186. Soverini S, Martinelli G, Colarossi S, et al. Presence or the emergence of a F317L BCR-ABL mutation may be associated with resistance to dasatinib in Philadelphia chromosome-positive leukemia. *J Clin Oncol* 2006;24:e51-52. Available at: <http://www.ncbi.nlm.nih.gov/pubmed/17114651>.

187. Soverini S, Hochhaus A, Nicolini FE, et al. BCR-ABL kinase domain mutation analysis in chronic myeloid leukemia patients treated with tyrosine kinase inhibitors: recommendations from an expert panel on behalf of European LeukemiaNet. *Blood* 2011;118:1208-1215. Available at: <http://www.ncbi.nlm.nih.gov/pubmed/21562040>.

188. Ariad Pharmaceuticals. Prescribing information: ICLUSIG® (ponatinib) tablets for oral use. 2014. Available at: <http://www.iclusig.com/hcp/wp-content/uploads/2014/10/October-2014-Iclusig-Prescribing-Information.pdf>. Accessed September 29, 2016.

189. Cortes JE, Kantarjian H, Shah NP, et al. Ponatinib in refractory Philadelphia chromosome-positive leukemias. *N Engl J Med* 2012;367:2075-2088. Available at: <http://www.ncbi.nlm.nih.gov/pubmed/23190221>.

190. Cortes JE, Kim DW, Pinilla-Ibarz J, et al. A phase 2 trial of ponatinib in Philadelphia chromosome-positive leukemias. *N Engl J Med* 2013;369:1783-1796. Available at: <http://www.ncbi.nlm.nih.gov/pubmed/24180494>.

191. Cortes JE, Kantarjian HM, Brummendorf TH, et al. Safety and efficacy of bosutinib (SKI-606) in chronic phase Philadelphia chromosome-positive chronic myeloid leukemia patients with resistance or intolerance to imatinib. *Blood* 2011;118:4567-4576. Available at: <http://www.ncbi.nlm.nih.gov/pubmed/21865346>.

192. Khoury HJ, Cortes JE, Kantarjian HM, et al. Bosutinib is active in chronic phase chronic myeloid leukemia after imatinib and dasatinib and/or nilotinib therapy failure. *Blood* 2012;119:3403-3412. Available at: <http://www.ncbi.nlm.nih.gov/pubmed/22371878>.

193. Ishida Y, Terasako K, Oshima K, et al. Dasatinib followed by second allogeneic hematopoietic stem cell transplantation for relapse of Philadelphia chromosome-positive acute lymphoblastic leukemia after the first transplantation. *Int J Hematol* 2010;92:542-546. Available at: <http://www.ncbi.nlm.nih.gov/pubmed/20824399>.

194. Millot F, Cividin M, Brizard F, et al. Successful second allogeneic stem cell transplantation in second remission induced by dasatinib in a child with Philadelphia chromosome positive acute lymphoblastic leukemia. *Pediatr Blood Cancer* 2009;52:891-892. Available at: <http://www.ncbi.nlm.nih.gov/pubmed/19202569>.

195. Collins RH, Jr., Goldstein S, Giral S, et al. Donor leukocyte infusions in acute lymphocytic leukemia. *Bone Marrow Transplant* 2000;26:511-516. Available at: <http://www.ncbi.nlm.nih.gov/pubmed/11019840>.

196. Kolb HJ, Schattenberg A, Goldman JM, et al. Graft-versus-leukemia effect of donor lymphocyte transfusions in marrow grafted patients. *Blood* 1995;86:2041-2050. Available at: <http://www.ncbi.nlm.nih.gov/pubmed/7655033>.

197. Keil F, Kalhs P, Haas OA, et al. Relapse of Philadelphia chromosome positive acute lymphoblastic leukaemia after marrow transplantation: sustained molecular remission after early and dose-escalating infusion of donor leucocytes. *Br J Haematol* 1997;97:161-164. Available at: <http://www.ncbi.nlm.nih.gov/pubmed/9136959>.

198. Matsue K, Tabayashi T, Yamada K, Takeuchi M. Eradication of residual bcr-abl-positive clones by inducing graft-versus-host disease after allogeneic stem cell transplantation in patients with Philadelphia chromosome-positive acute lymphoblastic leukemia. *Bone Marrow Transplant* 2002;29:63-66. Available at: <http://www.ncbi.nlm.nih.gov/pubmed/11840146>.

199. Yazaki M, Andoh M, Ito T, et al. Successful prevention of hematological relapse for a patient with Philadelphia chromosome-positive acute lymphoblastic leukemia after allogeneic bone marrow transplantation by donor leukocyte infusion. *Bone Marrow Transplant* 1997;19:393-394. Available at: <http://www.ncbi.nlm.nih.gov/pubmed/9051252>.

200. Tiribelli M, Sperotto A, Candoni A, et al. Nilotinib and donor lymphocyte infusion in the treatment of Philadelphia-positive acute lymphoblastic leukemia (Ph+ ALL) relapsing after allogeneic stem cell transplantation and resistant to imatinib. *Leuk Res* 2009;33:174-177. Available at: <http://www.ncbi.nlm.nih.gov/pubmed/18471874>.

201. Yoshimitsu M, Fujiwara H, Ozaki A, et al. Case of a patient with Philadelphia-chromosome-positive acute lymphoblastic leukemia relapsed after myeloablative allogeneic hematopoietic stem cell transplantation treated successfully with imatinib and sequential donor lymphocyte infusions. *Int J Hematol* 2008;88:331-335. Available at: <http://www.ncbi.nlm.nih.gov/pubmed/18696183>.

202. Tachibana T, Numata A, Tanaka M, et al. Successful treatment with dasatinib and allogeneic peripheral blood stem cell transplant for imatinib-resistant Philadelphia chromosome-positive acute lymphoblastic leukemia relapsing after bone marrow transplant and donor lymphocyte infusion. *Leuk Lymphoma* 2011;52:1376-1379. Available at: <http://www.ncbi.nlm.nih.gov/pubmed/21438838>.

203. Topp MS, Kufer P, Gokbuget N, et al. Targeted therapy with the T-cell-engaging antibody blinatumomab of chemotherapy-refractory minimal residual disease in B-lineage acute lymphoblastic leukemia patients results in high response rate and prolonged leukemia-free



NCCN Guidelines Version 1.2017

Acute Lymphoblastic Leukemia

survival. *J Clin Oncol* 2011;29:2493-2498. Available at:

<http://www.ncbi.nlm.nih.gov/pubmed/21576633>.

204. Davila ML, Riviere I, Wang X, et al. Efficacy and toxicity management of 19-28z CAR T cell therapy in B cell acute lymphoblastic leukemia. *Sci Transl Med* 2014;6:224ra225. Available at:

<http://www.ncbi.nlm.nih.gov/pubmed/24553386>.

205. de Bont JM, Holt Bvd, Dekker AW, et al. Significant difference in outcome for adolescents with acute lymphoblastic leukemia treated on pediatric vs adult protocols in the Netherlands. *Leukemia* 2004;18:2032-2035. Available at: <http://www.ncbi.nlm.nih.gov/pubmed/15483674>.

206. Hallbook H, Gustafsson G, Smedmyr B, et al. Treatment outcome in young adults and children >10 years of age with acute lymphoblastic leukemia in Sweden: a comparison between a pediatric protocol and an adult protocol. *Cancer* 2006;107:1551-1561. Available at:

<http://www.ncbi.nlm.nih.gov/pubmed/16955505>.

207. Barry E, DeAngelo DJ, Neuberg D, et al. Favorable outcome for adolescents with acute lymphoblastic leukemia treated on Dana-Farber Cancer Institute Acute Lymphoblastic Leukemia Consortium Protocols. *J Clin Oncol* 2007;25:813-819. Available at:

<http://www.ncbi.nlm.nih.gov/pubmed/17327603>.

208. Nachman JB, La MK, Hunger SP, et al. Young adults with acute lymphoblastic leukemia have an excellent outcome with chemotherapy alone and benefit from intensive postinduction treatment: a report from the children's oncology group. *J Clin Oncol* 2009;27:5189-5194. Available at: <http://www.ncbi.nlm.nih.gov/pubmed/19805689>.

209. Larsen EC, Devidas M, Chen S, et al. Dexamethasone and high-dose methotrexate improve outcome for children and young adults with high-risk B-acute lymphoblastic leukemia: A report from Children's Oncology Group study AALL0232. *J Clin Oncol* 2016;34:2380-2388. Available at: <https://www.ncbi.nlm.nih.gov/pubmed/27114587>.

210. Ribera JM, Oriol A, Sanz MA, et al. Comparison of the results of the treatment of adolescents and young adults with standard-risk acute lymphoblastic leukemia with the Programa Espanol de Tratamiento en Hematologia pediatric-based protocol ALL-96. *J Clin Oncol* 2008;26:1843-1849. Available at:

<http://www.ncbi.nlm.nih.gov/pubmed/18398150>.

211. DeAngelo DJ, Dahlberg S, Silverman LB, et al. A multicenter phase II study using a dose intensified pediatric regimen in adults with untreated acute lymphoblastic leukemia [abstract]. *Blood* 2007;110:Abstract 587. Available at:

<http://abstracts.hematologylibrary.org/cgi/content/abstract/ashmtg;110/1/587>.

212. Huguet F, Leguay T, Raffoux E, et al. Pediatric-inspired therapy in adults with Philadelphia chromosome-negative acute lymphoblastic leukemia: the GRAALL-2003 study. *J Clin Oncol* 2009;27:911-918. Available at: <http://www.ncbi.nlm.nih.gov/pubmed/19124805>.

213. Douer D, Aldoss I, Lunning MA, et al. Pharmacokinetics-based integration of multiple doses of intravenous pegaspargase in a pediatric regimen for adults with newly diagnosed acute lymphoblastic leukemia. *J Clin Oncol* 2014;32:905-911. Available at:

<http://www.ncbi.nlm.nih.gov/pubmed/24516026>.

214. Stock W, Luger SM, Advani AS, et al. Favorable outcomes for older adolescents and young adults (AYA) with acute lymphoblastic leukemia (ALL): Early results of U.S. Intergroup Trial C10403 [abstract]. *Blood* 2014;124:Abstract 796. Available at:

<http://www.bloodjournal.org/content/124/21/796>.

215. GlaxoSmithKline. Prescribing information. ARRANON (nelarabine) injection. 2014. Available at:

<http://www.pharma.us.novartis.com/product/pi/pdf/arranon.pdf>.

Accessed September 29, 2016.

216. Winter SS, Dunsmore KP, Devidas M, et al. Safe integration of nelarabine into intensive chemotherapy in newly diagnosed T-cell acute

lymphoblastic leukemia: Children's Oncology Group Study AALL0434. *Pediatr Blood Cancer* 2015;62:1176-1183. Available at: <http://www.ncbi.nlm.nih.gov/pubmed/25755211>.

217. Maury S, Huguet F, Leguay T, et al. Adverse prognostic significance of CD20 expression in adults with Philadelphia chromosome-negative B-cell precursor acute lymphoblastic leukemia. *Haematologica* 2010;95:324-328. Available at: <http://www.ncbi.nlm.nih.gov/pubmed/19773266>.

218. Ribera JM, Oriol A, Bethencourt C, et al. Comparison of intensive chemotherapy, allogeneic or autologous stem cell transplantation as post-remission treatment for adult patients with high-risk acute lymphoblastic leukemia. Results of the PETHEMA ALL-93 trial. *Haematologica* 2005;90:1346-1356. Available at: <http://www.ncbi.nlm.nih.gov/pubmed/16219571>.

219. Cornelissen JJ, van der Holt B, Verhoef GE, et al. Myeloablative allogeneic versus autologous stem cell transplantation in adult patients with acute lymphoblastic leukemia in first remission: a prospective sibling donor versus no-donor comparison. *Blood* 2009;113:1375-1382. Available at: <http://www.ncbi.nlm.nih.gov/pubmed/18988865>.

220. Marks DI, Perez WS, He W, et al. Unrelated donor transplants in adults with Philadelphia-negative acute lymphoblastic leukemia in first complete remission. *Blood* 2008;112:426-434. Available at: <http://www.ncbi.nlm.nih.gov/pubmed/18398065>.

221. Marks DI, Wang T, Perez WS, et al. The outcome of full-intensity and reduced-intensity conditioning matched sibling or unrelated donor transplantation in adults with Philadelphia chromosome-negative acute lymphoblastic leukemia in first and second complete remission. *Blood* 2010;116:366-374. Available at: <http://www.ncbi.nlm.nih.gov/pubmed/20404137>.

222. Ram R, Gafter-Gvili A, Vidal L, et al. Management of adult patients with acute lymphoblastic leukemia in first complete remission:

systematic review and meta-analysis. *Cancer* 2010;116:3447-3457. Available at: <http://www.ncbi.nlm.nih.gov/pubmed/20564092>.

223. Yanada M, Matsuo K, Suzuki T, Naoe T. Allogeneic hematopoietic stem cell transplantation as part of postremission therapy improves survival for adult patients with high-risk acute lymphoblastic leukemia: a metaanalysis. *Cancer* 2006;106:2657-2663. Available at: <http://www.ncbi.nlm.nih.gov/pubmed/16703597>.

224. Linker C, Damon L, Ries C, Navarro W. Intensified and shortened cyclical chemotherapy for adult acute lymphoblastic leukemia. *J Clin Oncol* 2002;20:2464-2471. Available at: <http://www.ncbi.nlm.nih.gov/pubmed/12011123>.

225. Marks DI, Paietta EM, Moorman AV, et al. T-cell acute lymphoblastic leukemia in adults: clinical features, immunophenotype, cytogenetics, and outcome from the large randomized prospective trial (UKALL XII/ECOG 2993). *Blood* 2009;114:5136-5145. Available at: <http://www.ncbi.nlm.nih.gov/pubmed/19828704>.

226. Mohty M, Labopin M, Volin L, et al. Reduced-intensity versus conventional myeloablative conditioning allogeneic stem cell transplantation for patients with acute lymphoblastic leukemia: a retrospective study from the European Group for Blood and Marrow Transplantation. *Blood* 2010;116:4439-4443. Available at: <http://www.ncbi.nlm.nih.gov/pubmed/20716774>.

227. Nguyen K, Devidas M, Cheng SC, et al. Factors influencing survival after relapse from acute lymphoblastic leukemia: a Children's Oncology Group study. *Leukemia* 2008;22:2142-2150. Available at: <http://www.ncbi.nlm.nih.gov/pubmed/18818707>.

228. Pui CH, Evans WE. Acute lymphoblastic leukemia. *N Engl J Med* 1998;339:605-615. Available at: <http://www.ncbi.nlm.nih.gov/pubmed/9718381>.

229. Pui CH, Pei D, Sandlund JT, et al. Long-term results of St Jude Total Therapy Studies 11, 12, 13A, 13B, and 14 for childhood acute



NCCN Guidelines Version 1.2017

Acute Lymphoblastic Leukemia

lymphoblastic leukemia. *Leukemia* 2010;24:371-382. Available at: <http://www.ncbi.nlm.nih.gov/pubmed/20010620>.

230. Einsiedel HG, von Stackelberg A, Hartmann R, et al. Long-term outcome in children with relapsed ALL by risk-stratified salvage therapy: results of trial acute lymphoblastic leukemia-relapse study of the Berlin-Frankfurt-Munster Group 87. *J Clin Oncol* 2005;23:7942-7950. Available at: <http://www.ncbi.nlm.nih.gov/pubmed/16258094>.

231. Tallen G, Ratei R, Mann G, et al. Long-term outcome in children with relapsed acute lymphoblastic leukemia after time-point and site-of-relapse stratification and intensified short-course multidrug chemotherapy: results of trial ALL-REZ BFM 90. *J Clin Oncol* 2010;28:2339-2347. Available at: <http://www.ncbi.nlm.nih.gov/pubmed/20385996>.

232. Malempati S, Gaynon PS, Sather H, et al. Outcome after relapse among children with standard-risk acute lymphoblastic leukemia: Children's Oncology Group study CCG-1952. *J Clin Oncol* 2007;25:5800-5807. Available at: <http://www.ncbi.nlm.nih.gov/pubmed/18089878>.

233. Genzyme Corporation. Prescribing information. Clolar® (clofarabine) injection for intravenous use. 2014. Available at: <http://products.sanofi.us/clolar/clolar.html>. Accessed September 29, 2016.

234. Jeha S, Gaynon PS, Razzouk BI, et al. Phase II study of clofarabine in pediatric patients with refractory or relapsed acute lymphoblastic leukemia. *J Clin Oncol* 2006;24:1917-1923. Available at: <http://www.ncbi.nlm.nih.gov/pubmed/16622268>.

235. Kantarjian H, Gandhi V, Cortes J, et al. Phase 2 clinical and pharmacologic study of clofarabine in patients with refractory or relapsed acute leukemia. *Blood* 2003;102:2379-2386. Available at: <http://www.ncbi.nlm.nih.gov/pubmed/12791647>.

236. Locatelli F, Testi AM, Bernardo ME, et al. Clofarabine, cyclophosphamide and etoposide as single-course re-induction therapy for children with refractory/multiple relapsed acute lymphoblastic leukaemia. *Br J Haematol* 2009;147:371-378. Available at: <http://www.ncbi.nlm.nih.gov/pubmed/19747360>.

237. Hijiya N, Thomson B, Isakoff MS, et al. Phase 2 trial of clofarabine in combination with etoposide and cyclophosphamide in pediatric patients with refractory or relapsed acute lymphoblastic leukemia. *Blood* 2011;118:6043-6049. Available at: <http://www.ncbi.nlm.nih.gov/pubmed/21967976>.

238. Miano M, Pistorio A, Putti MC, et al. Clofarabine, cyclophosphamide and etoposide for the treatment of relapsed or resistant acute leukemia in pediatric patients. *Leuk Lymphoma* 2012;53:1693-1698. Available at: <http://www.ncbi.nlm.nih.gov/pubmed/22303898>.

239. O'Connor D, Sibson K, Caswell M, et al. Early UK experience in the use of clofarabine in the treatment of relapsed and refractory paediatric acute lymphoblastic leukaemia. *Br J Haematol* 2011;154:482-485. Available at: <http://www.ncbi.nlm.nih.gov/pubmed/21689087>.

240. Pigneux A, Sauvezie M, Vey N, et al. Clofarabine combinations in adults with refractory/relapsed acute lymphoblastic leukemia (ALL): A GRAALL report [abstract]. *Blood* 2011;118:Abstract 2586. Available at: <http://abstracts.hematologylibrary.org/cgi/content/abstract/118/21/2586>.

241. Faderl S, Thomas DA, O'Brien S, et al. Augmented hyper-CVAD based on dose-intensified vincristine, dexamethasone, and asparaginase in adult acute lymphoblastic leukemia salvage therapy. *Clin Lymphoma Myeloma Leuk* 2011;11:54-59. Available at: <http://www.ncbi.nlm.nih.gov/pubmed/21454191>.

242. Thomas DA, Kantarjian HM, Stock W, et al. Phase 1 multicenter study of vincristine sulfate liposomes injection and dexamethasone in adults with relapsed or refractory acute lymphoblastic leukemia. *Cancer*

2009;115:5490-5498. Available at:

<http://www.ncbi.nlm.nih.gov/pubmed/19708032>.

243. Silverman JA, Reynolds L, Deitcher SR. Pharmacokinetics and pharmacodynamics of vincristine sulfate liposome injection (VSLI) in adults with acute lymphoblastic leukemia. *J Clin Pharmacol* 2013;53:1139-1145. Available at:

<http://www.ncbi.nlm.nih.gov/pubmed/23907766>.

244. O'Brien S, Schiller G, Lister J, et al. High-dose vincristine sulfate liposome injection for advanced, relapsed, and refractory adult Philadelphia chromosome-negative acute lymphoblastic leukemia. *J Clin Oncol* 2013;31:676-683. Available at:

<http://www.ncbi.nlm.nih.gov/pubmed/23169518>.

245. O'Brien S, Thomas D, Ravandi F, et al. Outcome of adults with acute lymphocytic leukemia after second salvage therapy. *Cancer* 2008;113:3186-3191. Available at:

<http://www.ncbi.nlm.nih.gov/pubmed/18846563>.

246. Spectrum Pharmaceuticals. Prescribing information: Marqibo® (vinCRiStine sulfate LIPOSOME injection) for intravenous infusion 2012. Available at: <http://www.marqibo.com/>. Accessed September 29, 2016.

247. Topp MS, Gokbuget N, Zugmaier G, et al. Phase II trial of the anti-CD19 bispecific T cell-engager blinatumomab shows hematologic and molecular remissions in patients with relapsed or refractory B-precursor acute lymphoblastic leukemia. *J Clin Oncol* 2014;32:4134-4140. Available at:

<http://www.ncbi.nlm.nih.gov/pubmed/25385737>.

248. Topp MS, Goekbuget N, Zugmaier G, et al. Anti-CD19 BiTE blinatumomab induces high complete remission rate in adult patients with relapsed B-precursor ALL: Updated results of an ongoing phase II trial [abstract]. *Blood* 2011;118:Abstract 252. Available at:

<http://abstracts.hematologylibrary.org/cgi/content/abstract/118/21/252>.

249. Topp MS, Gokbuget N, Stein AS, et al. Safety and activity of blinatumomab for adult patients with relapsed or refractory B-precursor acute lymphoblastic leukaemia: a multicentre, single-arm, phase 2 study. *Lancet Oncol* 2015;16:57-66. Available at:

<http://www.ncbi.nlm.nih.gov/pubmed/25524800>.

250. Topp MS, Goekbuget N, Stein AS, et al. Confirmatory open-label, single-arm, multicenter phase 2 study of the BiTE antibody blinatumomab in patients (pts) with relapsed/refractory B-precursor acute lymphoblastic leukemia (r/r ALL) [abstract]. *J Clin Oncol* 2014;32:Abstract 7005. Available at:

<http://meetinglibrary.asco.org/content/129500-144>.

251. U.S. Food and Drug Administration. Prescribing information. Blincyto® (blinatumomab) injection. 2014. Available at:

http://www.accessdata.fda.gov/drugsatfda_docs/label/2014/125557lbl.pdf. Accessed September 29, 2016.

252. Brentjens RJ, Davila ML, Riviere I, et al. CD19-targeted T cells rapidly induce molecular remissions in adults with chemotherapy-refractory acute lymphoblastic leukemia. *Sci Transl Med* 2013;5:177ra138. Available at:

<http://www.ncbi.nlm.nih.gov/pubmed/23515080>.

253. Kochenderfer JN, Dudley ME, Feldman SA, et al. B-cell depletion and remissions of malignancy along with cytokine-associated toxicity in a clinical trial of anti-CD19 chimeric-antigen-receptor-transduced T cells. *Blood* 2012;119:2709-2720. Available at:

<http://www.ncbi.nlm.nih.gov/pubmed/22160384>.

254. Grupp SA, Kalos M, Barrett D, et al. Chimeric antigen receptor-modified T cells for acute lymphoid leukemia. *N Engl J Med* 2013;368:1509-1518. Available at:

<http://www.ncbi.nlm.nih.gov/pubmed/23527958>.

255. Sadelain M, Riviere I, Brentjens R. Targeting tumours with genetically enhanced T lymphocytes. *Nat Rev Cancer* 2003;3:35-45. Available at:

<http://www.ncbi.nlm.nih.gov/pubmed/12509765>.

256. Hollyman D, Stefanski J, Przybylowski M, et al. Manufacturing validation of biologically functional T cells targeted to CD19 antigen for autologous adoptive cell therapy. *J Immunother* 2009;32:169-180. Available at: <http://www.ncbi.nlm.nih.gov/pubmed/19238016>.

257. Gokbuget N, Stanze D, Beck J, et al. Outcome of relapsed adult lymphoblastic leukemia depends on response to salvage chemotherapy, prognostic factors, and performance of stem cell transplantation. *Blood* 2012;120:2032-2041. Available at: <http://www.ncbi.nlm.nih.gov/pubmed/22493293>.

258. Park JH, Riviere I, Wang X, et al. CD19-targeted 19-28z CAR modified autologous T cells induce high rates of complete remission and durable responses in adult patients with relapsed, refractory B-cell ALL. Vol. 124; 2014.

259. Grupp SA, Frey NV, Aplenc R, et al. T Cells engineered with a chimeric antigen receptor (CAR) targeting CD19 (CTL019) produce significant in vivo proliferation, complete responses and long-term persistence without GVHD in children and adults with relapsed, refractory ALL [abstract]. *Blood* 2013;122:Abstract 67. Available at: <http://bloodjournal.hematologylibrary.org/content/122/21/67.short#aff-1>.

260. Maude SL, Frey N, Shaw PA, et al. Chimeric antigen receptor T cells for sustained remissions in leukemia. *N Engl J Med* 2014;371:1507-1517. Available at: <http://www.ncbi.nlm.nih.gov/pubmed/25317870>.

261. Kantarjian H, Thomas D, Jorgensen J, et al. Inotuzumab ozogamicin, an anti-CD22-calecheamicin conjugate, for refractory and relapsed acute lymphocytic leukaemia: a phase 2 study. *Lancet Oncol* 2012;13:403-411. Available at: <http://www.ncbi.nlm.nih.gov/pubmed/22357140>.

262. Kantarjian HM, DeAngelo DJ, Stelljes M, et al. Inotuzumab ozogamicin versus standard therapy for acute lymphoblastic leukemia. *N Engl J Med* 2016. Available at: <http://www.ncbi.nlm.nih.gov/pubmed/27292104>.

263. DeAngelo DJ, Stelljes M, Martinelli G, et al. Efficacy and safety of inotuzumab ozogamicin (INO) vs standard of care (SOC) in salvage 1 or 2 patients with acute lymphoblastic leukemia (ALL): An ongoing global phase 3 study [abstract]. Presented at: 20th Congress of the European Hematology Association (EHA) 2015;Vienna, Austria:Abstract LB2073. Available at: <http://www.ehawe.org/education-science/science/abstract-book-2/>.

264. Schiller G, Lee M, Territo M, et al. Phase II study of etoposide, ifosfamide, and mitoxantrone for the treatment of resistant adult acute lymphoblastic leukemia. *Am J Hematol* 1993;43:195-199. Available at: <http://www.ncbi.nlm.nih.gov/pubmed/8352235>.

265. Weiss MA, Aliff TB, Tallman MS, et al. A single, high dose of idarubicin combined with cytarabine as induction therapy for adult patients with recurrent or refractory acute lymphoblastic leukemia. *Cancer* 2002;95:581-587. Available at: <http://www.ncbi.nlm.nih.gov/pubmed/12209751>.

266. Hahn T, Wall D, Camitta B, et al. The role of cytotoxic therapy with hematopoietic stem cell transplantation in the therapy of acute lymphoblastic leukemia in adults: an evidence-based review. *Biol Blood Marrow Transplant* 2006;12:1-30. Available at: <http://www.ncbi.nlm.nih.gov/pubmed/16399566>.

267. Eapen M, Raetz E, Zhang MJ, et al. Outcomes after HLA-matched sibling transplantation or chemotherapy in children with B-precursor acute lymphoblastic leukemia in a second remission: a collaborative study of the Children's Oncology Group and the Center for International Blood and Marrow Transplant Research. *Blood* 2006;107:4961-4967. Available at: <http://www.ncbi.nlm.nih.gov/pubmed/16493003>.

268. Gupta V, Richards S, Rowe J, Acute Leukemia Stem Cell Transplantation Trialists' Collaborative G. Allogeneic, but not autologous, hematopoietic cell transplantation improves survival only among younger adults with acute lymphoblastic leukemia in first remission: an individual patient data meta-analysis. *Blood*

2013;121:339-350. Available at:

<http://www.ncbi.nlm.nih.gov/pubmed/23165481>.

269. Messori A, Fadda V, Maratea D, Trippoli S. Acute lymphoblastic leukemia in first complete remission: temporal trend of outcomes in studies comparing allogeneic transplant with autologous transplant or chemotherapy. *Ann Hematol* 2013;92:1221-1228. Available at:

<http://www.ncbi.nlm.nih.gov/pubmed/23677128>.

270. Bailey LC, Lange BJ, Rheingold SR, Bunin NJ. Bone-marrow relapse in paediatric acute lymphoblastic leukaemia. *Lancet Oncol* 2008;9:873-883. Available at:

<http://www.ncbi.nlm.nih.gov/pubmed/18760243>.

271. Hoelzer D, Gokbuget N, Digel W, et al. Outcome of adult patients with T-lymphoblastic lymphoma treated according to protocols for acute lymphoblastic leukemia. *Blood* 2002;99:4379-4385. Available at:

<http://www.ncbi.nlm.nih.gov/pubmed/12036865>.

272. Morel P, Lepage E, Brice P, et al. Prognosis and treatment of lymphoblastic lymphoma in adults: a report on 80 patients. *J Clin Oncol* 1992;10:1078-1085. Available at:

<http://www.ncbi.nlm.nih.gov/pubmed/1607914>.

273. Thomas DA, O'Brien S, Cortes J, et al. Outcome with the hyper-CVAD regimens in lymphoblastic lymphoma. *Blood* 2004;104:1624-1630. Available at: <http://www.ncbi.nlm.nih.gov/pubmed/15178574>.

274. Burger B, Zimmermann M, Mann G, et al. Diagnostic cerebrospinal fluid examination in children with acute lymphoblastic leukemia: significance of low leukocyte counts with blasts or traumatic lumbar puncture. *J Clin Oncol* 2003;21:184-188. Available at:

<http://www.ncbi.nlm.nih.gov/pubmed/12525508>.

275. Pui CH, Campana D, Pei D, et al. Treating childhood acute lymphoblastic leukemia without cranial irradiation. *N Engl J Med* 2009;360:2730-2741. Available at:

<http://www.ncbi.nlm.nih.gov/pubmed/19553647>.

276. Lazarus HM, Richards SM, Chopra R, et al. Central nervous system involvement in adult acute lymphoblastic leukemia at diagnosis: results from the international ALL trial MRC UKALL XII/ECOG E2993. *Blood* 2006;108:465-472. Available at:

<http://www.ncbi.nlm.nih.gov/pubmed/16556888>.

277. Reman O, Pigneux A, Huguet F, et al. Central nervous system involvement in adult acute lymphoblastic leukemia at diagnosis and/or at first relapse: results from the GET-LALA group. *Leuk Res* 2008;32:1741-1750. Available at:

<http://www.ncbi.nlm.nih.gov/pubmed/18508120>.

278. Pui CH, Pei D, Campana D, et al. Improved prognosis for older adolescents with acute lymphoblastic leukemia. *J Clin Oncol* 2011;29:386-391. Available at:

<http://www.ncbi.nlm.nih.gov/pubmed/21172890>.

279. Annino L, Vegna ML, Camera A, et al. Treatment of adult acute lymphoblastic leukemia (ALL): long-term follow-up of the GIMEMA ALL 0288 randomized study. *Blood* 2002;99:863-871. Available at:

<http://www.ncbi.nlm.nih.gov/pubmed/11806988>.

280. Sancho JM, Ribera JM, Oriol A, et al. Central nervous system recurrence in adult patients with acute lymphoblastic leukemia: frequency and prognosis in 467 patients without cranial irradiation for prophylaxis. *Cancer* 2006;106:2540-2546. Available at:

<http://www.ncbi.nlm.nih.gov/pubmed/16700036>.

281. Children's Oncology Group. Long-term follow-up guidelines for survivors of childhood, adolescent, and young adult cancers. 2013. Available at:

http://www.survivorshipguidelines.org/pdf/LTFUGuidelines_40.pdf.

Accessed September 29, 2016.

282. Mortuza FY, Papaioannou M, Moreira IM, et al. Minimal residual disease tests provide an independent predictor of clinical outcome in adult acute lymphoblastic leukemia. *J Clin Oncol* 2002;20:1094-1104. Available at: <http://www.ncbi.nlm.nih.gov/pubmed/11844835>.

283. Neale GA, Coustan-Smith E, Stow P, et al. Comparative analysis of flow cytometry and polymerase chain reaction for the detection of minimal residual disease in childhood acute lymphoblastic leukemia. *Leukemia* 2004;18:934-938. Available at: <http://www.ncbi.nlm.nih.gov/pubmed/15029212>.

284. Kerst G, Kreyenberg H, Roth C, et al. Concurrent detection of minimal residual disease (MRD) in childhood acute lymphoblastic leukaemia by flow cytometry and real-time PCR. *Br J Haematol* 2005;128:774-782. Available at: <http://www.ncbi.nlm.nih.gov/pubmed/15755280>.

285. Coustan-Smith E, Sancho J, Behm FG, et al. Prognostic importance of measuring early clearance of leukemic cells by flow cytometry in childhood acute lymphoblastic leukemia. *Blood* 2002;100:52-58. Available at: <http://www.ncbi.nlm.nih.gov/pubmed/12070008>.

286. Coustan-Smith E, Sancho J, Hancock ML, et al. Clinical importance of minimal residual disease in childhood acute lymphoblastic leukemia. *Blood* 2000;96:2691-2696. Available at: <http://www.ncbi.nlm.nih.gov/pubmed/11023499>.

287. Cave H, van der Werff ten Bosch J, Suci S, et al. Clinical significance of minimal residual disease in childhood acute lymphoblastic leukemia. European Organization for Research and Treatment of Cancer--Childhood Leukemia Cooperative Group. *N Engl J Med* 1998;339:591-598. Available at: <http://www.ncbi.nlm.nih.gov/pubmed/9718378>.

288. Coustan-Smith E, Behm FG, Sanchez J, et al. Immunological detection of minimal residual disease in children with acute lymphoblastic leukaemia. *Lancet* 1998;351:550-554. Available at: <http://www.ncbi.nlm.nih.gov/pubmed/9492773>.

289. Stow P, Key L, Chen X, et al. Clinical significance of low levels of minimal residual disease at the end of remission induction therapy in

childhood acute lymphoblastic leukemia. *Blood* 2010;115:4657-4663. Available at: <http://www.ncbi.nlm.nih.gov/pubmed/20304809>.

290. Conter V, Bartram CR, Valsecchi MG, et al. Molecular response to treatment redefines all prognostic factors in children and adolescents with B-cell precursor acute lymphoblastic leukemia: results in 3184 patients of the AIEOP-BFM ALL 2000 study. *Blood* 2010;115:3206-3214. Available at: <http://www.ncbi.nlm.nih.gov/pubmed/20154213>.

291. Vora A, Goulden N, Wade R, et al. Treatment reduction for children and young adults with low-risk acute lymphoblastic leukaemia defined by minimal residual disease (UKALL 2003): a randomised controlled trial. *Lancet Oncol* 2013;14:199-209. Available at: <http://www.ncbi.nlm.nih.gov/pubmed/23395119>.

292. Vora A, Goulden N, Mitchell C, et al. Augmented post-remission therapy for a minimal residual disease-defined high-risk subgroup of children and young people with clinical standard-risk and intermediate-risk acute lymphoblastic leukaemia (UKALL 2003): a randomised controlled trial. *Lancet Oncol* 2014;15:809-818. Available at: <http://www.ncbi.nlm.nih.gov/pubmed/24924991>.

293. Eckert C, Henze G, Seeger K, et al. Use of allogeneic hematopoietic stem-cell transplantation based on minimal residual disease response improves outcomes for children with relapsed acute lymphoblastic leukemia in the intermediate-risk group. *J Clin Oncol* 2013;31:2736-2742. Available at: <http://www.ncbi.nlm.nih.gov/pubmed/23775972>.

294. Parker C, Waters R, Leighton C, et al. Effect of mitoxantrone on outcome of children with first relapse of acute lymphoblastic leukaemia (ALL R3): an open-label randomised trial. *Lancet* 2010;376:2009-2017. Available at: <http://www.ncbi.nlm.nih.gov/pubmed/21131038>.

295. Ko RH, Ji L, Barnette P, et al. Outcome of patients treated for relapsed or refractory acute lymphoblastic leukemia: a Therapeutic Advances in Childhood Leukemia Consortium study. *J Clin Oncol*

2010;28:648-654. Available at:

<http://www.ncbi.nlm.nih.gov/pubmed/19841326>.

296. Coustan-Smith E, Gajjar A, Hijiya N, et al. Clinical significance of minimal residual disease in childhood acute lymphoblastic leukemia after first relapse. *Leukemia* 2004;18:499-504. Available at:

<http://www.ncbi.nlm.nih.gov/pubmed/14981525>.

297. Paganin M, Zecca M, Fabbri G, et al. Minimal residual disease is an important predictive factor of outcome in children with relapsed 'high-risk' acute lymphoblastic leukemia. *Leukemia* 2008;22:2193-2200.

Available at: <http://www.ncbi.nlm.nih.gov/pubmed/18754029>.

298. Basso G, Veltroni M, Valsecchi MG, et al. Risk of relapse of childhood acute lymphoblastic leukemia is predicted by flow cytometric measurement of residual disease on day 15 bone marrow. *J Clin Oncol* 2009;27:5168-5174. Available at:

<http://www.ncbi.nlm.nih.gov/pubmed/19805690>.

299. Panzer-Grumayer ER, Schneider M, Panzer S, et al. Rapid molecular response during early induction chemotherapy predicts a good outcome in childhood acute lymphoblastic leukemia. *Blood* 2000;95:790-794. Available at:

<http://www.ncbi.nlm.nih.gov/pubmed/10648387>.

300. Bruggemann M, Raff T, Flohr T, et al. Clinical significance of minimal residual disease quantification in adult patients with standard-risk acute lymphoblastic leukemia. *Blood* 2006;107:1116-1123.

Available at: <http://www.ncbi.nlm.nih.gov/pubmed/16195338>.

301. Holowiecki J, Krawczyk-Kulis M, Giebel S, et al. Status of minimal residual disease after induction predicts outcome in both standard and high-risk Ph-negative adult acute lymphoblastic leukaemia. The Polish Adult Leukemia Group ALL 4-2002 MRD Study. *Br J Haematol* 2008;142:227-237. Available at:

<http://www.ncbi.nlm.nih.gov/pubmed/18492099>.

302. Patel B, Rai L, Buck G, et al. Minimal residual disease is a significant predictor of treatment failure in non T-lineage adult acute lymphoblastic leukaemia: final results of the international trial UKALL XII/ECOG2993. *Br J Haematol* 2010;148:80-89. Available at:

<http://www.ncbi.nlm.nih.gov/pubmed/19863538>.

303. Vidriales MB, Perez JJ, Lopez-Berges MC, et al. Minimal residual disease in adolescent (older than 14 years) and adult acute lymphoblastic leukemias: early immunophenotypic evaluation has high clinical value. *Blood* 2003;101:4695-4700. Available at:

<http://www.ncbi.nlm.nih.gov/pubmed/12586618>.

304. Nagafuji K, Miyamoto T, Eto T, et al. Monitoring of minimal residual disease (MRD) is useful to predict prognosis of adult patients with Ph-negative ALL: results of a prospective study (ALL MRD2002 Study). *J Hematol Oncol* 2013;6:14. Available at:

<http://www.ncbi.nlm.nih.gov/pubmed/23388549>.

305. Bassan R, Spinelli O, Oldani E, et al. Improved risk classification for risk-specific therapy based on the molecular study of minimal residual disease (MRD) in adult acute lymphoblastic leukemia (ALL). *Blood* 2009;113:4153-4162. Available at:

<http://www.ncbi.nlm.nih.gov/pubmed/19141862>.

306. Raff T, Gokbuget N, Luschen S, et al. Molecular relapse in adult standard-risk ALL patients detected by prospective MRD monitoring during and after maintenance treatment: data from the GMALL 06/99 and 07/03 trials. *Blood* 2007;109:910-915. Available at:

<http://www.ncbi.nlm.nih.gov/pubmed/17023577>.

307. Gokbuget N, Kneba M, Raff T, et al. Adult patients with acute lymphoblastic leukemia and molecular failure display a poor prognosis and are candidates for stem cell transplantation and targeted therapies. *Blood* 2012;120:1868-1876. Available at:

<http://www.ncbi.nlm.nih.gov/pubmed/22442346>.

308. Dworzak MN, Froschl G, Printz D, et al. Prognostic significance and modalities of flow cytometric minimal residual disease detection in

childhood acute lymphoblastic leukemia. Blood 2002;99:1952-1958. Available at: <http://www.ncbi.nlm.nih.gov/pubmed/11877265>.

309. Bruggemann M, Schrauder A, Raff T, et al. Standardized MRD quantification in European ALL trials: proceedings of the Second International Symposium on MRD assessment in Kiel, Germany, 18-20 September 2008. Leukemia 2010;24:521-535. Available at: <http://www.ncbi.nlm.nih.gov/pubmed/20033054>.

310. Campana D. Minimal residual disease in acute lymphoblastic leukemia. Hematology Am Soc Hematol Educ Program 2010;2010:7-12. Available at: <http://www.ncbi.nlm.nih.gov/pubmed/21239764>.

311. Hughes WT, Rivera GK, Schell MJ, et al. Successful intermittent chemoprophylaxis for Pneumocystis carinii pneumonitis. N Engl J Med 1987;316:1627-1632. Available at: <http://www.ncbi.nlm.nih.gov/pubmed/3495732>.

312. Lindemulder S, Albano E. Successful intermittent prophylaxis with trimethoprim/sulfamethoxazole 2 days per week for Pneumocystis carinii (jiroveci) pneumonia in pediatric oncology patients. Pediatrics 2007;120:e47-51. Available at: <http://www.ncbi.nlm.nih.gov/pubmed/17606548>.

313. U.S. Food and Drug Administration. Prescribing information: BACTRIM™ sulfamethoxazole and trimethoprim DS (double strength) tablets and tablets USP. 2014. Available at: http://www.accessdata.fda.gov/drugsatfda_docs/label/2014/017377s074lbl.pdf. Accessed September 29, 2016.

314. Ferrazzini G, Klein J, Sulh H, et al. Interaction between trimethoprim-sulfamethoxazole and methotrexate in children with leukemia. J Pediatr 1990;117:823-826. Available at: <http://www.ncbi.nlm.nih.gov/pubmed/2231218>.

315. Ducore JM, Waller DA, Emslie G, Bertolone SJ. Acute psychosis complicating induction therapy for acute lymphoblastic leukemia. J

Pediatr 1983;103:477-480. Available at: <http://www.ncbi.nlm.nih.gov/pubmed/6577167>.

316. Friedenberg WR, Kyle RA, Knospe WH, et al. High-dose dexamethasone for refractory or relapsing multiple myeloma. Am J Hematol 1991;36:171-175. Available at: <http://www.ncbi.nlm.nih.gov/pubmed/1996557>.

317. Jenkins CA, Bruera E. Difficulties in diagnosing neuropsychiatric complications of corticosteroids in advanced cancer patients: two case reports. J Pain Symptom Manage 2000;19:309-317. Available at: <http://www.ncbi.nlm.nih.gov/pubmed/10799797>.

318. Stiefel FC, Breitbart WS, Holland JC. Corticosteroids in cancer: neuropsychiatric complications. Cancer Invest 1989;7:479-491. Available at: <http://www.ncbi.nlm.nih.gov/pubmed/2695230>.

319. Kawedia JD, Kaste SC, Pei D, et al. Pharmacokinetic, pharmacodynamic, and pharmacogenetic determinants of osteonecrosis in children with acute lymphoblastic leukemia. Blood 2011;117:2340-2347; quiz 2556. Available at: <http://www.ncbi.nlm.nih.gov/pubmed/21148812>.

320. Mattano LA, Jr., Devidas M, Nachman JB, et al. Effect of alternate-week versus continuous dexamethasone scheduling on the risk of osteonecrosis in paediatric patients with acute lymphoblastic leukaemia: results from the CCG-1961 randomised cohort trial. Lancet Oncol 2012;13:906-915. Available at: <http://www.ncbi.nlm.nih.gov/pubmed/22901620>.

321. Mattano LA, Jr., Sather HN, Trigg ME, Nachman JB. Osteonecrosis as a complication of treating acute lymphoblastic leukemia in children: a report from the Children's Cancer Group. J Clin Oncol 2000;18:3262-3272. Available at: <http://www.ncbi.nlm.nih.gov/pubmed/10986059>.

322. te Winkel ML, Pieters R, Hop WC, et al. Prospective study on incidence, risk factors, and long-term outcome of osteonecrosis in



NCCN Guidelines Version 1.2017

Acute Lymphoblastic Leukemia

pediatric acute lymphoblastic leukemia. *J Clin Oncol* 2011;29:4143-4150. Available at: <http://www.ncbi.nlm.nih.gov/pubmed/21947829>.

323. Vora A. Management of osteonecrosis in children and young adults with acute lymphoblastic leukaemia. *Br J Haematol* 2011;155:549-560. Available at: <http://www.ncbi.nlm.nih.gov/pubmed/22077340>.

324. Vrooman LM, Stevenson KE, Supko JG, et al. Postinduction dexamethasone and individualized dosing of Escherichia coli L-asparaginase each improve outcome of children and adolescents with newly diagnosed acute lymphoblastic leukemia: Results from a randomized study--Dana-Farber Cancer Institute ALL Consortium protocol 00-01. *J Clin Oncol* 2013. Available at: <http://www.ncbi.nlm.nih.gov/pubmed/23358966>.

325. Asselin BL. The three asparaginases. Comparative pharmacology and optimal use in childhood leukemia. *Adv Exp Med Biol* 1999;457:621-629. Available at: <http://www.ncbi.nlm.nih.gov/pubmed/10500842>.

326. Pieters R, Hunger SP, Boos J, et al. L-asparaginase treatment in acute lymphoblastic leukemia: a focus on Erwinia asparaginase. *Cancer* 2011;117:238-249. Available at: <http://www.ncbi.nlm.nih.gov/pubmed/20824725>.

327. Stock W, Douer D, Deangelo DJ, et al. Prevention and management of asparaginase/pegasparaginase-associated toxicities in adults and older adolescents: recommendations of an expert panel. *Leuk Lymphoma* 2011;52:2237-2253. Available at: <http://www.ncbi.nlm.nih.gov/pubmed/21827361>.

328. Avramis VI, Sencer S, Periclou AP, et al. A randomized comparison of native Escherichia coli asparaginase and polyethylene glycol conjugated asparaginase for treatment of children with newly diagnosed standard-risk acute lymphoblastic leukemia: a Children's Cancer Group study. *Blood* 2002;99:1986-1994. Available at: <http://www.ncbi.nlm.nih.gov/pubmed/11877270>.

329. Wang B, Relling MV, Storm MC, et al. Evaluation of immunologic crossreaction of antiasparaginase antibodies in acute lymphoblastic leukemia (ALL) and lymphoma patients. *Leukemia* 2003;17:1583-1588. Available at: <http://www.ncbi.nlm.nih.gov/pubmed/12886246>.

330. Zalewska-Szewczyk B, Gach A, Wyka K, et al. The cross-reactivity of anti-asparaginase antibodies against different L-asparaginase preparations. *Clin Exp Med* 2009;9:113-116. Available at: <http://www.ncbi.nlm.nih.gov/pubmed/19184328>.

331. Willer A, Gerss J, Konig T, et al. Anti-Escherichia coli asparaginase antibody levels determine the activity of second-line treatment with pegylated E coli asparaginase: a retrospective analysis within the ALL-BFM trials. *Blood* 2011;118:5774-5782. Available at: <http://www.ncbi.nlm.nih.gov/pubmed/21940824>.

332. Vrooman LM, Supko JG, Neuberg DS, et al. Erwinia asparaginase after allergy to E. coli asparaginase in children with acute lymphoblastic leukemia. *Pediatr Blood Cancer* 2010;54:199-205. Available at: <http://www.ncbi.nlm.nih.gov/pubmed/19672973>.

333. Jazz Pharmaceuticals. Prescribing information. Asparaginase Erwinia chrysanthemi ERWINAZE™ for injection, intramuscular use. 2014. Available at: <http://www.erwinaze.com/ERWINAZEPI.pdf>. Accessed September 29, 2016.

334. Bleyer A, Asselin BL, Koontz SE, Hunger SP. Clinical application of asparaginase activity levels following treatment with pegaspargase. *Pediatr Blood Cancer* 2015;62:1102-1105. Available at: <http://www.ncbi.nlm.nih.gov/pubmed/25393506>.